



# VYSOKÉ UČENÍ TECHNICKÉ V BRNĚ

BRNO UNIVERSITY OF TECHNOLOGY

## FAKULTA STROJNÍHO INŽENÝRSTVÍ

FACULTY OF MECHANICAL ENGINEERING

## ÚSTAV MATEMATIKY

INSTITUTE OF MATHEMATICS

# VYBRANÉ POKROČILÉ MODELY STOCHASTICKÉHO PROGRAMOVÁNÍ

SELECTED ADVANCED STOCHASTIC PROGRAMMING MODELS

## DIPLOMOVÁ PRÁCE

MASTER'S THESIS

### AUTOR PRÁCE

AUTHOR

Bc. JAN BRZOBOHATÝ

### VEDOUCÍ PRÁCE

SUPERVISOR

RNDr. PAVEL POPELA, Ph.D.

BRNO 2022

# Zadání diplomové práce

Ústav:	Ústav matematiky
Student:	<b>Bc. Jan Brzobohatý</b>
Studijní program:	Aplikované vědy v inženýrství
Studijní obor:	Matematické inženýrství
Vedoucí práce:	<b>RNDr. Pavel Popela, Ph.D.</b>
Akademický rok:	2021/22

Ředitel ústavu Vám v souladu se zákonem č.1111/1998 o vysokých školách a se Studijním a zkušebním řádem VUT v Brně určuje následující téma diplomové práce:

## Vybrané pokročilé modely stochastického programování

### Stručná charakteristika problematiky úkolu:

Student se seznámí s problematikou řešení složitých optimalizačních úloh. Zaměří se na pokročilé modely stochastického programování a metody jejich řešení. Důraz bude kladen na návrh pokročilých modelů, modifikace řešících algoritmů a jejich efektivní softwarové implementace. Student se z pohledu řešitelnosti uvažovaných úloh bude také zabývat studiem vlastností optimalizačních modelů a jejich vhodnými transformacemi. Vybrané modely bude implementovat pomocí vhodně zvoleného softwarového nástroje a provede testovací výpočty. Předpokládá se zapojení studenta do řešení optimalizačních úloh vybraných výzkumných projektů a diskuse tématu za účasti konzultantů specialistů, a to jak v oblasti teorie, tak aplikací.

### Cíle diplomové práce:

1. Studium problematiky vybrané třídy složitých optimalizačních úloh.
2. Studium pokročilých modelů stochastického programování.
3. Studium vlastností a transformací vybraných modelů matematického programování pro zvolenou třídu úloh.
4. Návrh modifikací algoritmů pro studované modely.
5. Efektivní implementace modelů a algoritmů využívající řešiče matematického programování.
6. Testovací výpočty, případná aplikace na vybraný aplikační problém.

### Seznam doporučené literatury:

BIRGE, J. R. a LOUVEAUX, F. Introduction to Stochastic Programming. Springer Verlag, 1997. ISBN: 978-1-4614-0236-7.

KALL, P. a WALLACE, S. W. Stochastic Programming. New York: John Wiley & Sons, 1993. ISBN 978-0471951582.

WALLACE, S. W. and KING, A. Modeling with Stochastic Programming. Springer Verlag, 2012. ISBN 978-0-387-87816-4.

RUSZCZYNSKI, A. et al. Handbooks in Operations Research and Management Science, vol. 10: Stochastic Programming. Amsterdam: Elsevier, 2003. ISBN 978-0-444-50854-6.

BAZARAA, M. S., SHERALI, H. D. a SHETTY, C. M. Nonlinear programming: theory and algorithms. 2nd ed. New York: John Wiley & Sons, 1993. ISBN 0471599735.

Termín odevzdání diplomové práce je stanoven časovým plánem akademického roku 2021/22

V Brně, dne

L. S.

---

doc. Mgr. Petr Vašík, Ph.D.  
ředitel ústavu

---

doc. Ing. Jaroslav Katolický, Ph.D.  
děkan fakulty

, 4szq Vž

y-zb eq<C sC<-4 f—ebU C\ szb<P-szS\W @b\ S'-^<C- UCPb -eYSW< f bezS -YS-<S@bQ  
eqf^<P YbPi ; Y\ eq<CUCebYb S<-WV @%eqp ^-@C' ^bf-^ ebU ~>ebes-^ UCPb PYfQ  
^<P fY-sz^bsz - f%sf zY^ zbPbzb ebU ~ ^- U@^b@-P <P e WV @C^Pi ?-Y \ <Y\ UC  
-eYSWf-z ebx^-zV%b szb<P-szS\W @b\ S'-^<S^ Lq Hbf YbP%qpx C^ b eqfOW^-Pb@%  
fCHbq\ ^-Pb@^ <C^%o} e WV @ -fC@C^ <P f z zb eq<SUCz-W ^-YGC^ CC^ - W@  
eqp eqpLq \ bf-< U<%W/e%zPb^i

r ~\ \ -q%

y PS @eYb\ - zPCSS @G Ys ..SZP szb<P-szS @b\ S'-^<C y PC Lb-Ys zb Y%zPC Hb-^@zSb^s  
Hbq@C' ^S'L szb<P-szS @b\ S'-^<Czb @Cs<qSIC Ss eqpeCqzSS -^@zb CteY S' zPS <b^<Cez b^  
sS eYCCt-\ eYCi , ^bzPCqLb-Ys zb -eeY%zPS <b^<Cez zb ^Cz..bqWep4Y\ s ..SZP q ^@b\  
eq<C B†-\ eYCs S' zPS zPCSS -Yb <b^z-S' sbY-zSb^s -^@e%zPb^ <b@CPb...zb " ^@zPC\ i

V Yčbf—sYbf-

r zb<P-szS\W @b\ S'-^<C>szb<P-szS\W eqpLq \ bf-^ >Lq Hbf YbP%bezS -YS-<C>L-qp4S  
YbLS\W\W\W YbP%o

V C%o.bq@s

r zb<P-szS @b\ S'-^<C>szb<P-szS eqpLq \ \ S'L>^Cz..bqW•b..s>bezS S-zSb^>L-qp4S YbQ  
LSzSs

3pŠa 3a O, y >Ti, %q^ ebWqčSY \ b@C%szb<P-szS\WPb eqpLq \ bf-^ i 3q^b=, %bW  
-qC^ zC-P^S\W f 3q^ >G-W\Z- szcpU^ Pb S' C^ qzf >|Œ|i J\_ si , C@b-< p] ? q d-fCY  
dbeCY >dPi? i

ddpPY ~US CUS @Sv\ bfb~ eq←S^- z \ - ,, %4q ^ ebVdpçS \ b@Cf%szb<P-sQ  
zSkWPb eqLq \ bf-^ " f%eq <bf-Ys \ bsz-z^ seb- Sz \ ~fC@C^ YzCq-z-d%o eq \ C^ i

3<i T-^ 3q b4bP-z



? W\Se-^~ p] ? q d-fY- dbeObfS>dPi? i><- b@4bq^ fC@C^ eq<D

3<i T-^ 3q b4bP-z





# ci fb@

, z zb eq<SsC4~@<-4 f-z ebU \ C szb<P-szSW @b\ S'-^<C9>|:i TC@^~sC b szbQ  
<P-szSW~ bezS -S-ç^ \ Czb@>eb~ f-^b- e Cf-^ f QW^b\ S y-zb @S\ b f-eq<C  
\ -< Yebes-z - -e\ S\ b f-z zC^zb ebU \ ^- q <^ z%%o YbP z-W-4%U\ bPYf%% z S  
czC^~ 4G e Q@Pbx <P <W C^bsz i

, @q-P WeSbYC ^-@C ^-U \ C szb<P-szSW~ @b\ S'-^<Seqf^ Pb>@q-P Pb - z Cz Pb  
sz-e^ ff U^ YCq-z- C ^-q<S ^- bx ^-çC^ -@g - ^<bq^ sSUC -W-C C ^- ^ V\ S\ V  
f<bdpf <P e W @C-Pi 3~@ \ C sz~@bf-z <W @^ fY-sz^bszSszb<P-szSW @b\ S'-^<Cs @ Q  
q<C ^- 4~@b~< -e\ S\ W<D

, Cz Cz WeSbYC sC4~@C C<-4 f-z -e\ S\ W< szb<P-szSW @b\ S'-^<Cf @beqf i } W@  
C C s\ Czb@%W\ Cq ^- \ bPb~ eb\ b<S<fb\ S ç-s>W@%sC f%@z ^- <Cz~>-4%Pb\  
s <b ^Uf z eqf@eb@4^bsz @bq<SSfç-si y%z \ Czb@%f%% f-U< szb<P-szSW~ @bQ  
\ S'-^<Sebdpf^> C s bsz-z^ \ S\ Czb@ \ S- -W-C C s s<b \ -U sebYç^ Pb - U W sC @ U  
f%% zi

, Cz f q WeSbYC s~W-C C \ b@Y<Obç sC^ Pb Y^G-e^ Pb eqLq \ bf-^ >W\ Cq \ U@C  
PY@z C C^ YbP @b\ S'-U< U^~ C C^ szb<P-szSW~ @b\ S'-^<i dbz ebe C C^ W\ Cq  
YbP% zCbç Lq H - -W-C C s S U WUC C Si rb-ç-sz z <Pzb YbP 4~@C S C C^ - W@  
f eqLq \ bf-< \ U<%C e%zPb^>fC W\ Cq \ 4~@C Ceb~ f-z C Sç L~q4S

, <f q sPq^C C f s\ C@W%eq<D

# kX aiQ+? biB+F€ /QKBM M+2

#v+?QK bB mF€x HB- D F THBFQp i biQ+? biB+FQm /QKBM  
biQ+? biB+F€ /QKBM M+2 D2 D Fû DbQm D2DQ pH biMQbiB-  
b2xM€KBiX

aiQ+? biB+F€ /QKBM M+2 D2 T`€i biQ+j?9b8)B #FQKQ+TQ Qj2 @  
`û?Q b2 / DQ TQ`QpM€p i ü2 2MQ M€?Q/Mw+? biQ+? biB+Fw  
b2 TQm^Qp€ p2 2FQMqKBB UbpQ+H2 KÛQF2HM/ DQw#ÿ`m QTIBK€H  
TüB M2DBbiQiÿX Jv bB H2 mF€^2K2- ^2 U p/ H Q+? F TBiQH€+  
/QKBM M+B TQm^Qi B p DBMw+? Uiü2# BM^2Mw`bFw+?V 9HQ?

aiQ+? biB+F€ /QKBM M+2 M€Ki2/v /€p€KQ^MQbipv#` ix2 p  
i FQpû ü2 2MQ- Fi2`û D2 MÿD FwK xTibQ#2K M2DH2T QX L2DÍ  
MÿD Fû TüQTmbiMû ü2 2MQ- Fi2`û b2 bM ^QK2 Tü2FQM i- H2  
iQiQ ü2 2MQ M2pvm^BD2X E iQKm b2 H2 /Qbi M2K2 ^ p/ H Q+

o iüiQ F TBiQH2 b2 #m/2K2 x #wp i i2Q`BQ biQ+? biB+Fû /Q  
9HQ?€+?X aiQ+? biB+F€ /QKBM M+2 T`Q KBMBK HBx ÍMQ 9H  
Í2M TQx/ÿDBX

# kXRX aiQ+? biB+F€ /QKBM M+2 T`pMQ?Q

.2}MB+2(R K2+?# DbQm M€?Q/Mû F(x+G(x)) D b Qm D2DB+? /Bbi`  
7mMF+2X û2FM2K2- ^2 M€?Q/M€ T`QKÿMMQKBMmD2 M€?Q/MQ  
T`pMQK bimTMÿK D2biHB^2

$$F(x) \quad G(x) \quad 8x^2 R$$

$$F(x) < G(x) \quad T`Q \quad MÿD2 R:û$$

L T`pMQ TQ?H2/ b2 Ki^2 x/€i M2HQ;B+Fû- ^2 TüB K tBK HBx  
#mÍMQ 7mMF+2X û2FM2K2- ^2 M€?Q/M€ T`QKÿMMQKBMmD2 M€?Q/MQ  
/QKBMQp Mû M€?Q/M€ PTT Q KÿMMH2 TQ^ /mD2K2- #v #vH /Bbi  
/QKBMmDQ+Q M€?Q/Mû T`QKÿMMû K2M Q- T`QiQ^2 K tBK HB  
S`QiQ^2 /Bbi`B#mÍMQ 7mMF+2FDQ MQ(F)H2D DEQ2+Qp-B7p #i2 M2Mÿ T  
i F- ^2 TH iQ

$$P( \quad x ) = P( \quad x ) ) \quad x \quad x ;$$

pBx Q#`k€xM Fi2`ûK DbQm xQ#` x2Mv /Bbi`B#mÍMQ 7mMF+2 /pC

SüQFHw FxmbK2 /2}MB+B biQ+? biB+Fû /QKBM M+2 T`pMQ?Q bi  
TüQFH /X "m/2K2 +?iQi BMP2biQp i /QAD2-Q-D X2wÍB bF FQFKQ/ÜB  
FQKQ/Biv D2 M€?Q/M€ p2HBÍBM /2}MQp kx€ M€bH2/mDQ+QK

E Qpÿü2MQ biQ+? biB+Fû /QKBM M+2 T`pMQ?Q bimTMÿ TQiü  
D2/MQiHBpw+? M€?Q/Mw+? T`QKÿMMQ#? X 2M D B Q QppMÿ, FQK  
A KQ/ü2- FQKQ/Bp2Mÿ2H2Mÿ M FQM D+}FQKQÿ Bio iQKiQ ;` 7m  
/Q#ü2 pB/ÿi- ^2 KQ/`€ M€?Q/M€ /M€ /QKÿMMQ M € p 2KB Qbi iMQKE  
T`QKÿMMwKB, T`QxP2 R/D 2 BKQ/`€ /Bbi`B#mÍMQ 7mMF+2 pÿi Q  
/Bbi`B#mÍMQ 7mMF+2 Qbi iMQ+? FQKQ/Bi M MÿFQHBF BM

kXRX ahP\* > ahA\*E • .PJAL L\*1 S\_oLP>P ahISLp

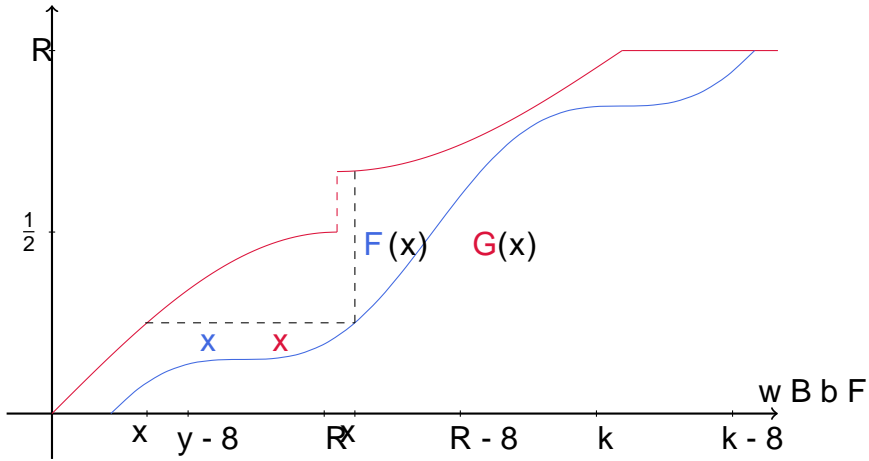

P#` €x2F kXR, SQ` QpM€MQ /Bbi` B#míMQ+? 7mMF+Q TüB

A	y-8	R	R-8	B	y-e	R-3	R-N
	y-j	y-k	y-8		y-j	y-98	y-k8
c	y-d8	R-e	k-k8		R	k	k-9
	y-k8	y-j8	y-9		y-9	y-j	y-j

h #mHF kXR, S` p/ÿTQ/Q#MQbiMQ `Qx/ÿH2MQ pwMQ

i2/v TQ/KQMFm mp2/2MQm p /2}MB+BX ‡€ /M€ / H Q BMp2biB+2 m  
 DBMQmX o2xKÿK2 bB M BTüQXF B`QBxMp2FyBe D2 Qbiü2 pÿi Q /Bbi`B#  
 M€?Q/Mû T`QKÿMMQT F TüB xBbFm R-e D2 Qbiü2 pÿi Q /Bbi`B#mí  
 T`QKÿMMQT SQ/Q#Mÿ iQ Hx2 mF€ B;DB C;DQX/pQDB+2

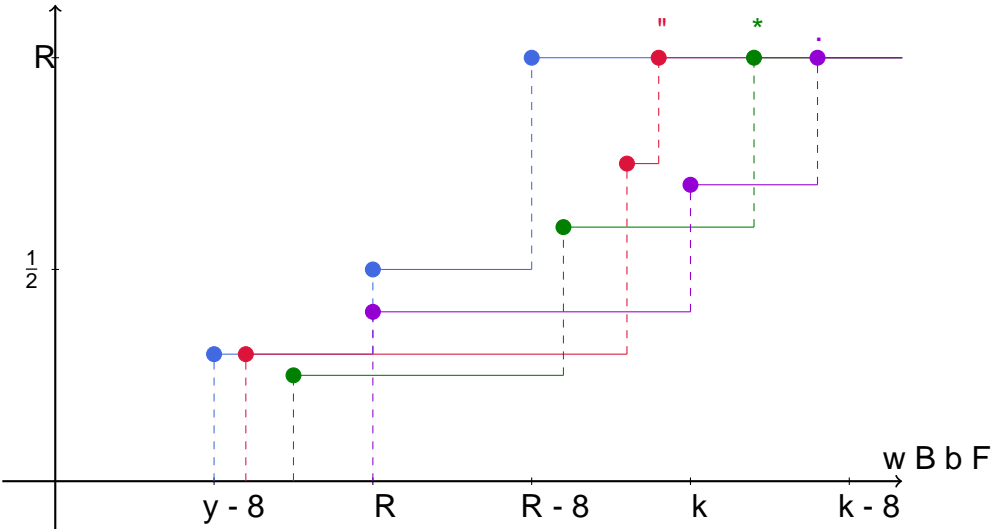

P#` €x2F kXk, .Bbi` B#míMQ 7mMF+2X

C F #vHQ mF€x€MQ p TüQFH /m- 2tBbimDQ TQ`QpM i2HMû B  
T`QKÿMMw+?X C F D2 iQ i2/v b2 biQ+? biB+FQm /QKBM M+Q  
Q/TQpQ M€bH2/mDQ+Q pÿi X

oÿi R(aiQ+? biB+F€ /QKBM M+2 T`pMQ?Q bimTMÿ D2 Qbi`û Í  
^BMÿ M€?Q/Mw+? T`QKÿMMw+?X

.iF xX2H R D2 Qbi`wK Í€bi2ÍMwK mbTQü€M€TQK rM/ bKTMHÿ ñBDMÿ  
M€bH2/mDQ+Q TQ/KQMFv,

Ç8a2 M : : aRa MiB`2~2tBpBi - i2/v ^€/M M TM p2MFQKpM`Q1HB MB b +  
b2 b2#Qm-

Ç8a;b;c2 M : (aRb^ bRç) aRc i` MxBiBpBi - i2/v a p2@HBBF bpT`Fp F2H  
b T`p D D2 p`2H +B b-TT pFF K bQ #avp`i F H ç-B b

Ç8a;b2 M : aRb): bRa MiBbvK2i`B2- i2/v TQFm/aD2 T`p`F2 K+ B T`  
T F M2Ki^2 #wi p`2 b b+B` F F2KF

S`pMQ TQ/KQMFm biQ+? biB+F€ /QKBM M+2 bTHšmD2- T`Q  
?Q/Mû T`QKÿMMû M2Ki^2 #wi p ^€/MûK #Q/ÿ Qbiü2 pÿi Q M2^ D  
aiQ+? biB+F€ /QKBM M+2 T`pMQ?Q bimTMÿ;ÿ D2biQFm M€ MQ BMB  
T`QKÿMM;F ;F DbQm D2DB+? /Bbi`B#mÍMQ 7mMF+2X1.€H2 Tü  
1 X JmbQ i2/v TH iBiiviQ /pÿ M2`QpMB+2,

$$F(x) = F(x) - 8x^2 R;$$

$$F(x) = F(x) - 8x^2 R:$$

w MB+? D2/MQxM ÍMÿ pvTHwp€

$$F(x) = F(x) - 8x^2 R:$$

w Tü2/TQFH1 /m Fû THvM2- ^2 Km D2R2tBFQp-i^2

$$F(*) < F(*):$$

S`QiQ^2 - KmbQ #wi p bTCHMÿM i Fû FQKCFM X o #Q/ÿ2/v  
M bi€p€ bBim +2

$$F(*) < F(*) = F(*):$$

L HB DbK2iR /vFQpû- ^2 D2 bTHMÿM B /`m?€ TQ/KQMF biQ  
T`pMQ?Q bimTMÿ- Xi2/v

LvMQ m^ M€K x#wp€ D2M mF€x i- ^2 biQ+? biB+F€ /QKBM M  
K2i`B+F€X L2+X \$ QiQK 2 b2Brm DF2Q pûF (\* < F(\*) X h iQ M2`QpMQb  
pvHmÍmD2 MF2(\*)QpM(\*)bipvHmÍmD2 i2/X B

\_2H b2Q+? biB+Fv /QKBMmD2 2/vp MTKS biDn2TMÿK ?Mv iüB TQ/  
i`û?Q Í€bi2ÍMû?Q mbTQü€/€MQX □

kXRX ahP\*> ahA\*E•.PJAL L\*1 S\_oLP>P ahISLp

LmiMQm TQ/KQMFQm- #v KQ?H D2/M M€?Q/M€T`QKÿMM€ /Q  
T`QKÿMMQm biQ+? biB+FQm /QKBM M+Q T`pMQ?Q bimTMÿ i2?/v D2M i2?/v- F/vû D`QHF/MQm m^Bi  
7mMF+Q b2 M2xK2 Q F ü Q`BK TüQT /ÿ D2 M H2pQ Q/ FûQ^2MQ pÿi Q  
7mMF+2 pT` pQ Q/ FûQ^2MQ D2 pÿi Q i /`m?€X

Ip2âK2 i Fû 2FpBp H2MiMQ /2}MB+B biQ+? biB+Fû /QKBM M+2  
MmiMû TQbi ÍmDQ+Q TQ/KQMFvX L2DT`p2 H2xK2 Q p Qi D?2 iQ m  
K2xB bm#D2FiBpMQK m^BiF2K p x€pBbHQbiB M bFmi2ÍMûK xBbF  
#m/2 KQi pÿi Q m^Bi2F U` /QbiV x T`pMQ?Q pv/ÿH Mû?Q KBHBQM  
/mDQ+Q pÿiÿ #m/2K2 TQ` /Qp i- #v #vH i iQ m^BiFQp€ 7mMF+2`  
D2 x+2H TüB`Qx2Mw- T`QiQ^2 Tü2/TQFH€ /€K2- ^2 ÍQK pQ+ K€K2

oÿi kXR) L€?Q/M€ T`QKÿMMQm D2 M€?Q/MQm iQ+QKÿiBMQm /QKB@  
M M+Q T`pMQ?Q bimTMÿ i2?/v D2M i2?/v- F/vû D`QHF/MQm m^Bi  
/2`Bpu0>Q TH iQ

$$1 u( ) \quad 1 u( )$$

2tBbimD2 H2bTQš D2/Mu0-mT`BQFQp€Q7mMF+2Q M2`QpMQbi Qbi`€

$$1 u_0( ) > 1 u_0( ) :$$

.iF xX2DT`p2 T`Q xD2/MQ/m 2M2xK2 Q F H Q K 2g Í-QB H`€ bTHšmDQ  
F(a) = F(a) = 0 F(b) = F(b) = 1 X w ÍM2K2 BKTHBF +Q

$$1 u( ) \quad 1 u( ) ^{u^0 > 0} ) \quad 1 :$$

ovD/2K2 x mT` p2Mû M2`QpMQbiB

$$0 \quad 1 u( ) \quad 1 u( ) :$$

aiü2/MQ?Q/MQim i` Mb7Q`KQp Mû M€?Q)Mû p2u(x)BíBMxX TQÍQi€K  
S`QiQ^2 Q#ÿ M€?Q/Mû T`QKÿMMû Kp DQ M2MmHQpQm ?mbiQim T`  
i2`p (a,b) - Ki^2K2 x9^Bi K2x2 BM(2)) = H\_a u(x)M(x) /x X \_Qx/QH biü2/MQ+?  
?Q/MQi D2 i2/v

$$1 u( ) \quad 1 u( ) = \int_a^{Z_b} u(x) f(x) \quad f(x) /x:$$

AMi2;` +Q T2` T`i2b xQbF€K2

$$\int_a^{Z_b} u(x) f(x) \quad f(x) /x = \int_a^h u(x) F(x) \quad F(x) \int_a^{i_b} \int_a^{Z_b} u^0(x) F(x) \quad F(x) /x:$$

w€pQ`F Tü2/ BMi2;` €H2K D2 FQp MF (M)mb2p B p Q Q`M DQX .Q HB  
DbK2 i2/v F M2`QpMQbiB

$$0 \quad \int_a^{Z_b} u^0(x) F(x) \quad F(x) /x:$$

S`QiQ^2 DbK2 Tü2pT`QFD/€ /QHBMi2;` €H bQmÍBMm HB#QpQH Mû FH  
7mMF+QX #v #vH i2MiQ B Mi2;` €HF M2 x €FT(Q`8M Q (ak)X QBTKQ iBi  
B Mi2(ap)HD bQm bB /Bbi`B#mÍMQ 7mMF+2`QpMv TH iQ i2/v

$$F(x) \quad F(x) \quad 8x^2 R:$$

e

S`QiQ^2 DbK2 imiQ M2`QpMQbi un-F^0€x0-HNB2T Qp MB#Qp H M UT`Q  
i FQpQmiQuXmMF+B  
o2 pÿiÿ DbK2 /€H2 Tü2/TQFH€ / HB 2tBbi2M+B`Q FFQ ð üQm^ Bi2  
1u0( ) > 1u0( ) X S`Q imiQ 7mMF+B KmbQ TH iBi

$$Z_b$$
$$0 < \int_a u_0^0(x) F(x) F(x) /x:$$

JmbQ i2/v 2tBbiQ(xj; B)Mii FQpHv- ^2 M MÿK TH iQ

$$F(x) < F(x) \quad 8x^2(x_0; x_1):$$

L HB DbK2 i2/v BMi2`p H- M Fi2`ûK D2 bTHMÿM /`m?€ TQ/K  
T`pMQ?Q biir2 TMÿi-Q+? biB+Fv TQ K B Q K D 2m TMÿKX  
SQ/Qp2DK2 b2 MvMQ M QT ÍMQm BKTHBF +BX S ü2F TQ FH € /2  
^ F (\*) > F (\*) X S`Q FQF2DbQm /Bbi`B#mÍMQ 7mMF+2- DbQm xT` p  
"> 0 T`Q Fi2`û TH iQ

$$F(x) > F(x) \quad 8x^2(*; *+ "):$$

wpQHK2 m^BiFQp Q rñ-7m2MF2+ BQMbi MiMQ(M ; B)Mi2`p; H 2+?  
M B Mi2`p(x; H) D2 bTQDBi€ `QbiQm+QX SQiQK D2DQ /2`Bp +  
h; \*+ ") MmHQp€ KBKQ MÿDX wM ÍQK2

$$u^0(x) = \begin{matrix} + & x^2 h; *+ " ); \\ 0 & DBM/2X \end{matrix}$$

S`QiQ`Q^2 DBKQ B Mi2`p "H MmHQp€- TH iQ

$$Z_b$$
$$Z_{*+}$$
$$\int_a u^0(x) F(x) F(x) /x = \int_a u^0(x) F(x) F(x) /x:$$

.€H2 H2 M B M 2`p THhF(\*) > F(\*) -F(x) F(x) < 0- K€K2 i2/v BMi2@  
;`€H x2 bQmÍB Mm FH /Mû x€TQ`Mû 7mMF+2- Fi2Mw /QKbQM#wD 2  
- M2Ki^2 M w( j) 1 1u( ) 8u; u^0 > 0X  
S`Q /BbF`ûiMQ bKQ 2MQm M€?Q/MQm T`QKÿMMQm D2 /iF

SQ^ / p2 F 0 b2 /€ D2/MQ/m 2 Q/ipQ/MBiX \_Qx?Q/Qp i2H- F  
D2bTQFQD2 MQD pQ + xQbF€X S`QiQ KmbQ KQi`QbiQm+Q m^Bi  
`Qx?Q/Qp i2H- Fi2`w bB pv#Q`€ TQKQ+Q biQ+? biB+Fû /QKBM  
M bviMw- i2/v M2pv#Q`€ bB KQ^MQbi b ?Q` Q biü2/MQ ?Q/MQi

SüQFHSQ/Qp2DK2 b2 xMQpm M M€ TüQFH /X aiü2/MQ ?Q/MQ  
1( )=1;1- ( )=1;465- ( )=1;6275 1( )=1;72X PT` p/m- D2/BM€ /QKBM  
FQKQ/Bi K€ M2DK2M Q biü2/MQ ?Q/MQimX w#vHû iüB FQK  
?Q/MQiv- H2 iQ D2 iÿ MmiMÿ M2xM K2M€- ^2 MÿFi2`€ x MB+? /  
b KQiM€ M2MQ TQbi ÍmDQ+Q F m`Í2MQ biQ+u(b) iB + F ü 1; Q KBM M  
D2 u( \*) ÷ 0;29 1u( ) ÷ 0;21X wü2DKÿ i2/W 2M Q KBM miD2+? biB+FQn  
/QKBM M+Q T`pMQ?Q bimTMÿ MB M QT FX

L FQM2+ bB Tü2/bi pQK2 /p xD2/MQ/m 2Mû TüQT /vX S`pMC  
?Q/Mû T`QKÿMMû #m/Qm /BbF`ûiMQ #m/Qm KQi D2M /pÿ ?Q/M

kXRX ahP\*> ahA\*E•.PJAL L\*1 S\_oLP>P ahISLp

SüQFHJŸXK2 bB Tü2/bi pBi bBim +B- ^2 TH€MmD2K2 xBKMQ /QpQ  
`€K2 biü2/BbFQ- Fi2`û +?+2K2 M p iQpBi- H2 M2pQK2 x iQK- D2b  
xBK X S`QiQ`2 bB +?+2K2 x Hv^Qp i- +?iÿHB #v+?QK pv#` i iQ biü2  
pQ+2 bMÿ?mX JQ^M€ iQ i F M2pvT /€- H2 B i /v Ki^2K2 TQm^Qi bi  
ov#2`K2 bB /pÿ bAü2/BbFQFm/ #m/2 i2TH€ xBK -Mp bMÿü2/BbFmK  
bMÿ?m p2 bBü2/BbFmQ 8 +K bMÿ?mX o /`m?ûK TüQT /ÿ- i2/v TQFm  
xBK - M bMÿ^Q p T`pMQK B p /`m?ûK biü2/BbFm p v#2K2bMÿü2/BbFm  
M T`pMQ TQ?H2/- H2 B TQKQ+Q biQ+? bB+BûT/QKBM ÛNK+TüQo@ bi  
T /ÿ M T /M2 H2bTQš iQHBF bMB?mTüQT /#2nb2üi2/BbFmBK - M T /  
p MÿK pQ+2 bMÿ?m MÿXp2 biü2/BbFm

aim/2M€ xBK

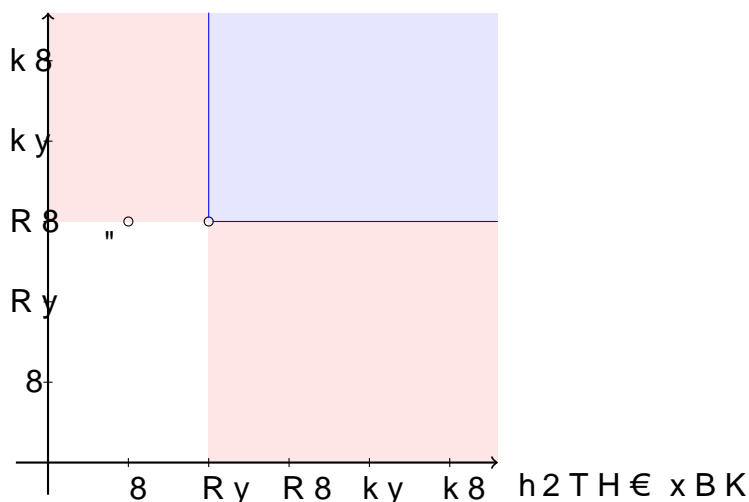

P#`€x2F kXj, SQ`QpM€MQ Hv^ übFw+? biü2/Bb2F TüB i2TH€

>H2/2DK2 H2 /€H biü2/BbFQ- Fi2`û #v KQ?HQ KQi H2T Q bMÿ?  
biü2/BbF M D/2K2\ SQ/Qp2DK2p22FM2`QK`E bQFA bBü2QB#`F@  
x2M X L pQ/Q`QpMû Qb2 D2 pw F M T /2Mû?Q bMÿ?m TüB i2THû  
bMÿ?m TüB bim/2Mû xBKÿX S`QiQ ?Q p ;` 7m x(5,15)XQ oš 2-D?M# Q /ü2/BbF - p2 Fi2`w+? M  
M2KûMÿ bMÿ?m M2^Ap-2i2iü2HBbQrp KQ/`ûK TQHBM o í2`p2MûK TQ  
biü2/BbF - Fi2`€ M2D/Qm TQKQ+Q biQ+? biB+AûT/QKBM Mx+2 T`p  
wKBšK2- ^2 i iQ í2`p2M€ KMQ^BM D2 Bi2Q ü2iM€KMQ2 bMü2MB2bTF QüQ  
o 2+?M biü2/BbF #v KÿH HQ;B+Fv T /MQmi M /Qbm Fp /` Mim  
pQ+ bMÿ?m- F/v^ #m/2 i2TH2DBX SQFm/ H2 TüBTmbiQK2- ^2 #v bB  
#vH M2x€pBbH€- i2/v^2 #v p D2/MQK biü2/BbFm KQ?H #wi+?H /  
i2TH€ xBK - xKÿMBH #v b2 bBim +2XXFo iQKiQ2TüQT /ÿxrnM2Ki@  
^2K2 QxM íBaiQ b2M€ xBK2TH€\x-BTK QiQ`2 D2 iQ x/2 T`Q F ^/û biü2/  
DBM FX SQFm/ M2`QxHB mD2K2 i2THQm bim/2MQm xBKm- KmbG  
B biü2/BbFpQ Fi2`ûK M T /M2 p D2/MQK TüQT /ÿ R8 +K bMÿ?m p  
Ry +K M QT F M2^ p2X iEü2/BbFm h2K2 ?H2/ i biü2/BbF - p2 Fi2`w+?  
pQ+2 bMÿ?m M2M p D2/MQK TüQT /ÿ- xQbF€K2 ?` MB+B KMQ^BM  
DQ+Q+? bAü2/BbFQ iB+FQm /QKBM M+Q T`pMQ (15; 12)nbBM 2X L TüQ  
M2/QKBM mD2Abiü22BQKBM mD2 b/`mA^2XMû#bii22F/BbFQ B Mv /QKBM m

KMQ^B Mm̂xQbF€K2 D2/MQ/m 2X JMQ^BM biü2/Bb2F M2/MQpM  
Q#b ?mD2 Íip2`2A^0K2QbQ DbQm i biü2/BbF - Fi2`€ #v /QKBMQ  
/QKBM M+Q T`pMQ?Q2bDbQmÿ/QKBMQpA^0M b/`m^2MwK

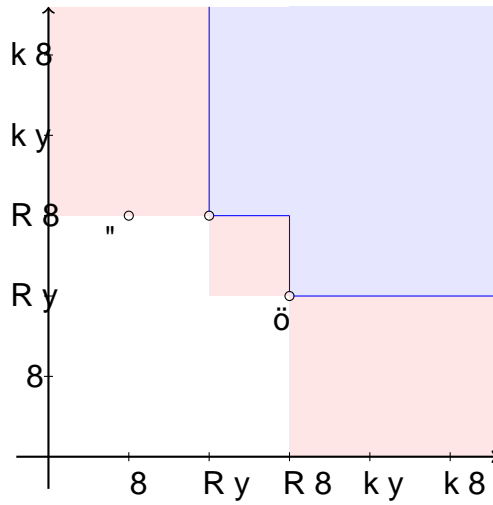

P#`€x2F kX9, SQ`QpM€MQ Hv^ übFw+? biü2/Bb2F TüB /pQ

hviQ;` 7v DbQm bB+2 TÿFMû Tü2?H2/Mû- H2 K DQ D2/Mm x  
xQ#` xBi D2M M€?Q/Mû T`QKÿMMû- Fi2`û M #wp DQ D2M /pQr  
TüB/ i / H Q bBim +B- iü2# T`iKÿ`MQm xBKm- Kmb2HB #v+?C  
M2pw?Q/Qm- Fi2`Qm kX29K2€TQjü27# - #v Q#ÿ bBim +2 KÿHv bi  
TQ/Q#MQbiX SQFm/ #v+?QK TQ`QpM€pb2BbMü 2/BQF2K/- lpi2i F/i2  
Ki^2 M bMÿ^Bi Rk +K M2#Q ky +K- M2Ki^2K2 üQ+i- D2biHB iQiQ  
/QKBM M+Q T`pMQ?Q bimTMÿ-/M2BQmD2iBiBiD/BQrQ M2TQ`QpM  
TQmx2 pvHQmíBiA^2QKBM/BDEQMQpû biü2/BbFQX S`QíiQKm i  
M ;` kX8 ì2`Mÿ D2 M F`2bH2M /Bbi`B#mÍM-Qx FmiY D+22T`Q/bimü?  
biü2/BbFQ- TQFm/ D2 pÿi Q T` p/ÿTQ/Q#MQbi- ^2 M bMÿ^Q ky  
pÿi Q T` p/ÿTQ/Q#MQbi- ^2 p2 /`m?ûK biü2/BbFm M bMÿ^Q Rk +  
?Q/M€T`QKÿMM€ /QKBMmD2 Í2`MQm M€?Q/MQm T`QKÿMMQm  
bimTMÿ- H2 } HQp€ b Í2`MQm DbQm M2TQ`QpM i2HMûX  
.`m?w bHB#Qp Mw xD2/MQ/m 2Mw TüQT / D2 i FQpw- p2 Fi  
/BbF`ûiMQ+? M€?Q/Mw+? T`QKÿMMw+? bi2DMQm T` p/ÿTQ/Q#  
TüQT /ÿ ?H2/ HB F2 xpQH2Mû M€?Q/MQm`QKÿMMQm #v M€K  
xM€i- D Fw+? ?Q/MQi M€?Q/Mw+? QMÿDM€2`Kmi +B- TQKQ+Q  
#vHB b+?QTMB mbTQü€/ iiviQ ?Q/MQiv i F- ^2 DbQm p^/v pÿi Q  
T`QKÿMMûQiQ b2 M€K #m/2 ?Q/Bi F TQíQi íQpûKm pwTQíim p2  
x p2/2K2 biQ+? biB+FQm /QKBM M+B /`m?û?Q bimTMÿX



kXkX ahP\* > ahA\*E • .PJAL L\*1 .\_|>ú>P ahISLp

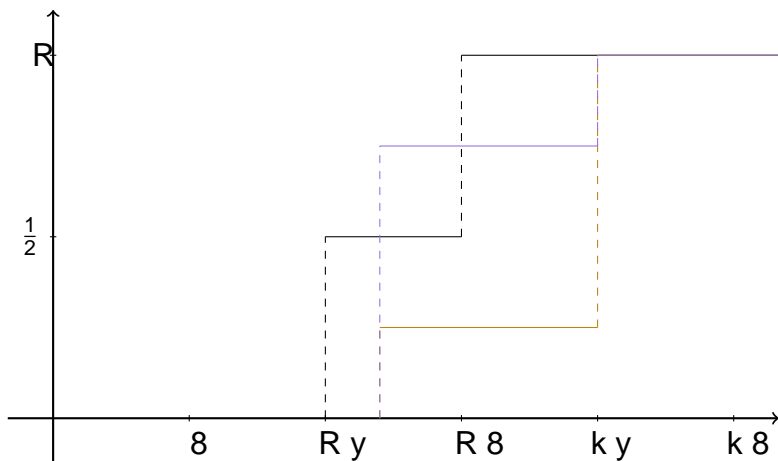

P#`€x2F kX8, .iH2^BiQbi T<sub>2</sub><sup>1</sup> Xp/ÿTQ/Q#MQbiB

kXkX aiQ+? biB+F€ /QKBM M+2 /`m?û?Q bim

.2}MB+2LQ+?# DbQm M€?Q/Mû F(w)KQ(M)MûbQm D2DB+? /Bbi`B#m  
 7mMF+2X û2FM2K2- ^2 M€?Q/MQm T`QKÿMMw+? - H2 TQ`QpM€p€K2 D2DB+? BM  
 /`m?wK bimTMÿK-UD2biHB^2

$$\begin{matrix} Z^x & Z^x \\ F(w) / w & G(w) / w \end{matrix} \quad 8x2R$$

$$\begin{matrix} Z^x & Z^x \\ F(w) / w < & G(w) / w \end{matrix} \quad T`Q MÿKD2 R:û$$

.2}MB+2 biQ+? biB+Fû /QKBM M+2 /`m?û?Q bimTMÿ b2 Q//2}MB  
 T`pMQ?Q bimTMÿ x/€MHBpÿ KQ+ M2HB QX SQmx2 i2MiQF`€i M2T  
 7mMF+2 M€?Q/Mw+? T`QKÿMMw+? - H2 TQ`QpM€p€K2 D2DB+? BM  
 x TüQbHm Mw+? /Bbi`B#míMQ+? 7mMF+QX

SüQFHSQ/Qp2DK2 b2 xMQpm M TüQFH / b2 íivüKB FQKQ/Bi KBX  
 +? biB+FQm /QKBM M+Q /`m?û?Q bimTMÿ TQiü2#mD2K2 xM€i BMi  
 x /Bbi`B#míMQ+? 7mMF+Q F ^/û FQKQ/BivX L kXk2 KT^2K2TQ/Qp  
 TQ?H2/ bB p BKM2K2- ^2 Q/ ?Q/MQiv A-Q DiZi Z p MiFQ2MFQ KQ2 B?Mv  
 Qbi iMQX C2 i2/v /QKBMQp€M p 2KB Qbi iMQKB FQKQ/Bi KB biQ  
 ?û?Q bimTMÿX 6mMF-D2FQK?Q/BM Qiv y-e Qbiü2 pÿi Q M2^ x2H2M€  
 D2 /QKBMQp€M /`m?wK bimTMÿK EQKQB DkE M px€D2K M2/Q@  
 KBMmDQ /`m?wK bimTMÿK- T`QiQ^2 MB D2/M Rk2MQ pÿi Q M2^ /`

oÿi jXRL2+?# DbQm M€?Q/Mû T`QKÿMMûX .QKBMmM€@Q/BM€?Q/  
 MQm T`QKÿMMûQm biB+FQm /QKBM M+Q1T`p-MQ?i Q K iDnBT MQyKUB MmD  
 i Fû biQ+? biB+FQm /QKBM M+Q X?m?û?Q bimTMÿ U

Ry

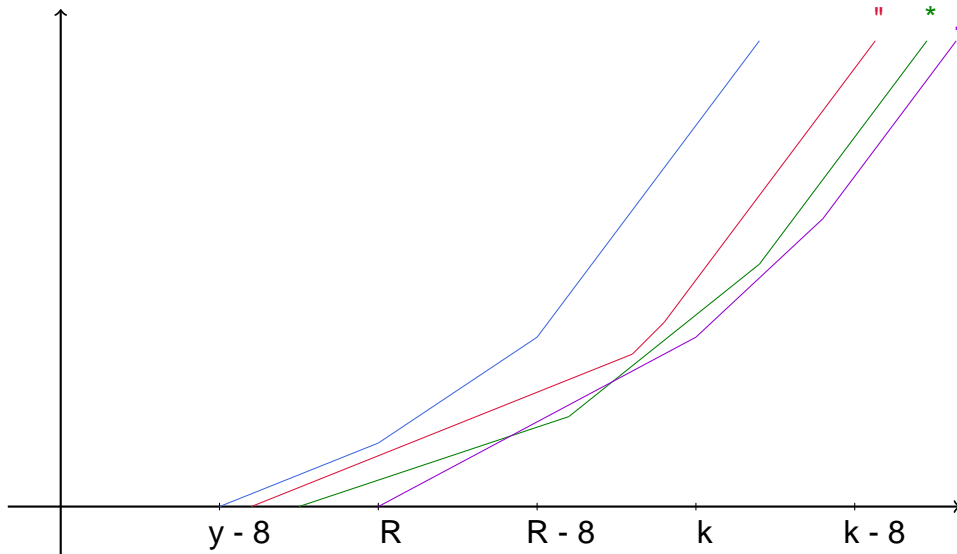

$P \# \epsilon x^2 F k X e, A M i 2 ; \epsilon H D F Q 7 m M F + 2 ? Q \backslash M Q K 2 x 2 x / B b$

.iF x X 2 + F # w) D 2 / B b i \ B # m \ M Q 7 m M F + 2 - 10 (w) Q B M ü p 2 H B M Q 7 m M  
 M \in ? Q / M ü p 2 H B i B M S Q / K Q M F m x / 2 \} M B + 2 b i Q + ? b i B + F ü / Q K B M  
 F(w) G(w) 8 x 2 R D / 2 2 F p B p H 2 M i F (w) p G(w) / ü B w 2 R X S Q i Q K T H i Q

$Z^x$

$$F(w) G(w) / w = 0 \quad 8w^2 R:$$

1

Sü 2 p 2 / 2 M Q K M \ Q x / Q H / p Q m B M i 2 ; \epsilon H i T ü 2 p 2 / 2 M Q K D 2 / M Q  
 F \in K 2 T ü 2 b M y T \ p M Q T Q / K Q M F m x / 2 \} M B + 2 b i Q + ? b i B + F ü / Q K B

$Z^x$

$Z^x$

$$F(w) / w = G(w) / w = 8x^2 R$$

1

1

w T ü 2 / T Q F H / m H v M 2 2 t B b i 2 M p 2 # Q 2 m ü K M F (i) \in G (x) X S \ Q i Q ^ 2  
 / B b i \ B # m \ M Q 7 m M F + 2 K m b Q # w i x T \ p b T Q D B i \in - M b i M 2 i i c  
 h ; \ + " i ; " > 0 X

SQ / H 2 T \ p M Q - m ^ / Q F \in x M ü - T Q / K Q M F v T H i Q

$Z^k$

$$F(w) G(w) / w = 0:$$

1

6 m M F (w) G(w) D 2 M B M i 2 ; \epsilon H i \in T Q \ M \in - i 2 / v

$Z^+$

$$F(w) G(w) / w < 0:$$

\*

L F Q M 2 + b Q m \ i 2 K M 2 F H / M ü ? Q x \in T Q \ M ü ? Q B M i 2 ; \epsilon H m x Q b F

$Z^+$

$Z^k$

$Z^+$

$$F(w) G(w) / w = F(w) G(w) / w + F(w) G(w) / w = 0:$$

1

1

\*

kXkX ahP\* > ahA\*E • .PJAL L\*1 . \_l > ú > P ahISLp

\_ Qx/ÿH2MQK B Mi2;` €Hm `Qx/QHm M `Qx/QH B Mi2;` €Hi M €bH2  
bi` Mm xQbF€K2 /`m?Qm TQ/KQMFm biQ+? biB+Fû /QKBM M+2 /`r

$$\frac{F(w)}{w} < \frac{G(w)}{w}$$

.QF€x HB DbK2 i2/v- /QKBMFmD2 Q+? biB+FQm /QKBM M+Q T`pMQ?  
TQiQK bTHšmD2 Q#ÿ TQ/KQMFv biQ+? biB+Fû /QKBM M+2 /`m?ú?  
B biQ+? biB+FQm /QKBM M+Q /`m?ú?Q bimTMÿX □

I FQKQ/BiDbK2 i2/v M2Kmb2HB FQMi`QHQP i B Mi2;` €H x /Bbi`B#  
xDBbiBHB- ^2 D2 /QKBMQp M€ biQ+? biB+FQm /QKBM M+Q /`m?ú?  
/Bi KBX

.€H2 /QFv Tü2/+?QxQ pÿiÿ bi€H2 TH iQ- ^2 `Qx?Q/Qp i2H pv#Q`  
KBM M+2 /`m?ú?Q bimTMÿ D2 bi€H2 M2M bviMwX L€bH2/mDQ+Q p  
`BxBFmX

oÿi 9X) L€?Q/M€ T`QKQMFmD2 M€?Q/MQm iQ+QKÿiBMBQm /QKB@  
M M+Q /`m?ú?Q bimTMÿ i2?/v D2M i2?/v- F/v`uTbCFH /MQmm`BiF  
T`pMQ x€TQ`MQm /`m?ú?Q bimTMÿ i2?/v D2M i2?/v- F/v`uTbCFH /MQmm`BiF

$$1 u( ) \quad 1 u( )$$

2tBbimD2 H2bTQš D2/M0 -mT`BQFFQp`€Q7mDM2F+2Q M2`QpMQbi Qbi`€

$$1 u_0( ) > 1 u_0( ) :$$

SüQFHF/XK2 bB- D F b2 p2`x2 F`BxBFm T`QD2pQ M K HûK TüQF  
T`QKÿMMQ#` x2MQm THMÿ M€?Q/MQm iQ+QKÿiBMBQm /QKB@  
?mbiQiv T` p/ÿTQ/Q#MQ b MB DbQ nB#m`M @ 7mM FkX2 Db2QmB pÿ;i- 7m  
^2 MB D2/M M2/QKBMmD2 /`m?Qm biQ+? biB+FQm /QKBM M+Q T  
B M B Mi2;` €Hv x /Bbi`B#m`MkX#7/2 MF2+ QBPÿ;i- 7m THMÿ M F`2bH  
D2 M M2i`BpB€HMqK B Mi2`p Hm Qbiü2 K2M Q ^2 MBF/2 M2MQ  
biQ+? biB+FQm /QKBM M+Q /`m?ú?Q bimTMÿX EkXdpB2Q M2Q pm TQ  
^2 Q#ÿ M€?Q/Mû T`QKÿMMû K DQ bi2DMQm kb2 M2QM`Q Q Di/MHQ ifri2`w  
Tü2/bi pmD2 K2M Q`BxBFQX

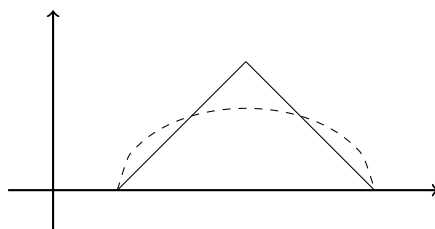

P#` €x2F kXd, \_ Qx/ÿH2MQ b2 bTQDBiQm ?mbiQiQm T` p/ÿ

o` #K2 b2 i Fû F 9p ?€K Q pQH#ÿ Hv` übFû?Q biü2/BbF X C F #  
biü2/Bb2F /QKBMmDQ+(Q0+15)büQ+?Bb5CB +FQm /QKBM M+Q /`m?ú?Q

Rk

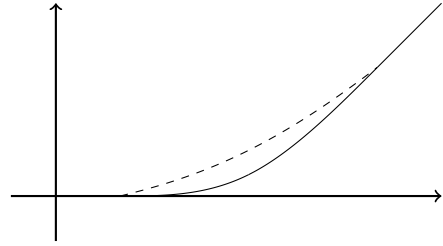
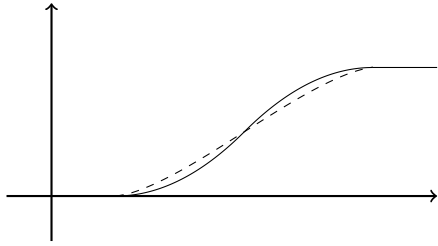

U V .Bbi`B#míMQ 7mMF+2X#V AMi2;`€Hv x /Bbi`B#míMQ+? 7  
 P#`€x2F kX3, SQ`QpM€MQ i` b b2 bTQDBiQm ?mbiQiQm

a DBbiQiQm Ki^2K2 üQ+i- ^2 iQ #m/Qm p 2A+0 MQ +b?i übi /BbFFQ mQ/QB  
 M M+Q T`pMQ?Q bimTMÿX oQK2- ^2 p2 biü 2V KmbQ+p ? QK BQmBDrc  
 M bMÿ^Bi H2bTQš iQHBF A FQH2BFT Qš Bi ü 2/BX) Fr# wp€ M€K i2/v`  
 Q biü2/Bb+Q+? p2Ái p2`U+BBK 2xXx

wFmbK2 i iQ biü2/BbF M DQi TQKQ+Q ;` 7m BMi2;`€Hi x /  
 x2 FXXS`QiQ^2 TQ^ /mD2K2- #v #vHv Q#ÿ bMÿ?Qpû M /QHFv bi  
 KQi BMi2;`€Hv b<sup>1</sup>/<sub>2</sub>KÿMMBQ M+ RX #v ?H2/ Mû biü2/BbFQ /QKBM  
 biQ+? biB+FQm /QKBM M+Q /`m?û?Q bimTMÿ- M2bKQ D2?Q ;`  
 MBF/v #wi M /AX 72K

>` MBíMQK TüQT /2K D2 bBim +2- F/v b2 Q/ MÿD Fû ?Q/MQiv  
 K2x2`QpM DQX h iQ bBim +2 Mx b iQ M Q- Fû/2`nb 2Q; p Mû í€ü2X Sü2  
 xHQK2K #m/2;` 7 ?H2/ Mû?Q biü2/BbF `QpMQ#ÿ AMwCb2 TMQM Q  
 i FQpû biü2/BbF Q XQp#;`x2M Q } HQpÿX C2 /Q#ü2 pB/ÿi- ^2 p ?`  
 KmbQ p ?Q` QK TüQT /ÿ M bMÿ^Bi K2xB Ry Rk-8 +K bMÿ?mX  
 Q/ MÿD Fû?Q #Q/m Tü2F`wp HAb Kmb2K KQü 2T/BiKÿ`MQm ?HQm#  
 Rk-8 +KX UhQiQ b2 /€ D2/MQ/m 2 pvíQbi x ;` 7m x€`Qp2š D2  
 /2}MB+Q biQ+? biB+Fû /QKBM M+2 /`m?û?Q bimTMÿVX

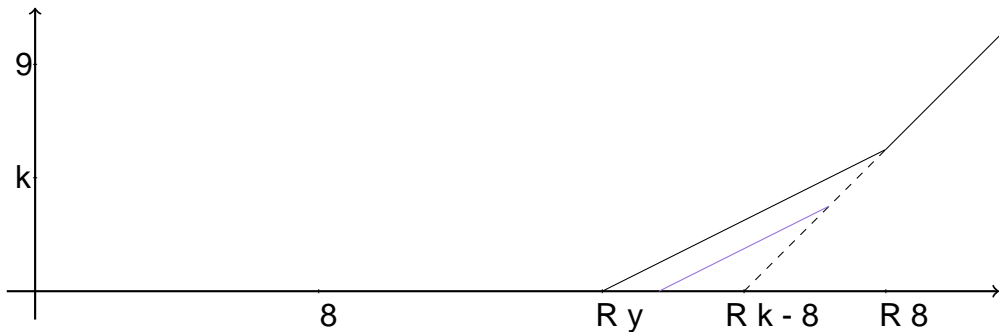

P#`€x2F kXN, AMi2;`€H x /Bbi`B#míMQ 7mMF+2

o ;` 7mX R x Q#` x mDQ+QK KMQ^B Mm biü2/Bb2 F mQKwBKMm rD Q@C  
 MÿK- b2 iviQ ?` MBíMQ ?Q/MQiv x Q#`A^XQaMü 29/B2ÍF mmk 2xBi ü i`Q  
 MQA m^0- UR8-R8V /QKBMmDQ biQ+? biB+FQm /QKBM M+Q T`p  
 biü2/BbFQ- Fi2`û /QKBMmD2 T`pMQK Biñ TMÿi M j i/QK B MFrQ Q /  
 bimTMÿK biAX/BbFQ F #Q/v H2^Q+QAp-A^0 QURy 2RHWQDFmQ m /QKBM  
 MÿD FwK #Q/2KA^0-bi2 FFA2 M2/QKBMmDQX

kXkX ahP\*> ahA\*E• .PJAL L\*1 .\_l>ú>P ahISLp

hQK DbK2 M H2xHB KMQ^BMmp 2+? Hv^ übFw+A biQ2/Bb2F /QKE  
 iB+FQm /QKBM M+Q /`m?û?Q bimTMÿX

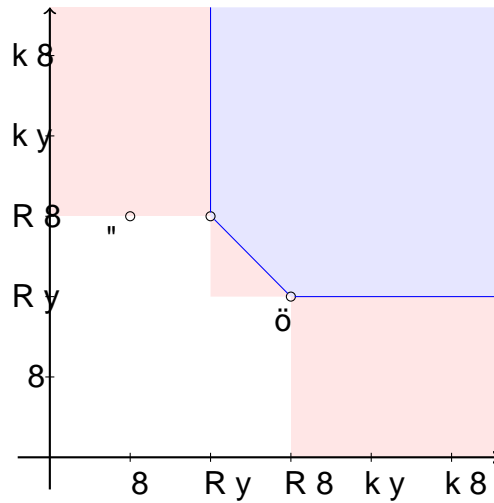

P#`€x2F kXRy, SQ`QpM€MQ Hv^ übFw+? biü2/Bb2F TüB /pQm

oÿi 8XiQ+? biB+F€ /QKBM M+2 /`m?û?Q bimTMÿ D2 Qbi`û Í€bi2ÍM

.iF xSQ/KQMF MiB`2~2tBpBiv D2 i`BpB€HMQX LmiMQm TQ/KQM  
 /`m?û?Q bimTMÿ D2- ^2 Bmi2;`€H x /Bbi`B#mÍMQ 7mMF+2 D FQ 7r  
 #Q/ÿ Qbiü2 pÿi QX h iQ TQ/KQMF p/QK BmDQpbBib KBb22#2vT`QiQ  
 bB #m/Qm Bmi2;`€Hv D FQ 7mMF+2 ?Q`MQ K2x2 B/2MiB+Fv`QpMv

SQ/Qp2DK2 b2 M i` MxBiBpBimX JyDK2 M€TüQ/BHmT QvKyBMBüi`  
 #mÍMQKB 7mMF+2KXBSü2/TQFH€/2DK2- ^2 X CbQm i2/v bTHMÿMv  
 iviQ TQ/KQMFv,

$$\begin{matrix} Z^x & & Z^x \\ F(w)/w & & F(w)/w & 8x2R; \\ 1 & & 1 \\ Z^x & & Z^x \\ F(w)/w & & F(w)/w & 8x2R: \\ 1 & & 1 \end{matrix}$$

wü2DKÿ i2/v TH iQ T`pMQ TQ/KQMF biQ+? biB+F2û /QKBM M+2 /`m

$$\begin{matrix} Z^x & & Z^x \\ F(w)/w & & F(w)/w & 8x2R: \\ 1 & & 1 \end{matrix}$$

SH iMQbi /`m?û TQ/KQMFv biQ+? biB+Fû /QKBM M+2 /`m?û?Q bi  
 TQ/Qp€K2 MQpû- ^2 p MÿK TH iQ

$$\begin{matrix} Z^* & & Z^* \\ F(w)/w & < & F(w)/w: \\ 1 & & 1 \end{matrix}$$

h FQp ûm`ÍBiÿ 2tBbimD2- T`QiQ^2 Tü2/XQ€H€K€Kü2/T2Q2FH /m THvM2

$$\begin{matrix} Z^* & & Z^* & & Z^* \\ F(w) / w < & F(w) / w & & F(w) / w; \\ 1 & & 1 & & 1 \end{matrix}$$

i2/v- ^2 TH iQ B /`m?€ TQ/KQMF biQ+? biB+Fû /QKBM M+2 /`m  
 hü2iQ TQ/KQMF bvK2i`B2 D2 i Fû p2HKB D2/MQ/mb+/B€X@ #v  
 i`B#mÍMQF7m/MQK+BM Qp H M€?Q/MQm bT / BKiÿ B#mQíM Q bímQF+Q  
 +? biB+FQm /QKBM M+Q /`m?û?QmbimQpMÿDU FûK#Qb/iü2 pÿi Q  
 ?Q/MQim BMi2;`€Hm D FQ 7mMFx2 ?Q`MQ K2x2- M2^ K€

$$\begin{matrix} Z^* & & Z^* \\ F(w) / w < & G(w) / w \\ 1 & & 1 \end{matrix}$$

o iQKiQ #Q/2/v M2Ki^2 /QKBMQp i M€?QbM€+T` Q Kÿ+M€m /QKBM  
 /`m?û?Q bimTMÿ M€?Q/MQm T`QKÿMMQm  
 \_2H b2Q+? biB+F€ /QKBM M+2i2/v bT H€mbDra TpMÿ+? Mv iüB T  
 Qbi`û?Q í€bi2ÍMû?Q mbTQü€ /€MQX □

kXjX aiQ+? biB+F€ /QKBM M+2 iü2iQ?Q bi

.2}MB+2LjX+?# DbQm M€?Q/Mû F(w)KQ(M)MDbQm D2DB+? /Bbi`  
 7mMF+2X û2FM2K2- ^2 M€?Q/MQm € b i B Kÿ W M Q K B M m D 2 M € ? Q / M Q  
 iü2iQK bimTMÿK- W2biHB^2 TH iQ

$$\begin{matrix} Z^x Z^z & & Z^x Z^z \\ F(w) / w / z & & G(w) / w / z & 8x 2 R \\ 1 & 1 & & 1 & 1 \end{matrix}$$

$$\begin{matrix} Z^x Z^z & & Z^x Z^z \\ F(w) / w / z < & G(w) / w / z & T`Q Mÿx2 R û \\ 1 & 1 & & 1 & 1 \end{matrix}$$

T`Q biü2/MQ ?Q/MQiv M pQ+ TH iQ  
 1( ) 1( ):

SüQFHwFxbK2 THBFQp i biQ+? biB+FQm /QKBM M+B iü2iQ?Q  
 FQKQ/Bi KBX .`m?û BMi2;`€Hv D bQ K B € #^ / û K M Q Pÿ; iQ M 2`Qp @  
 MQbiB

$$\begin{matrix} Z^x Z^z & & Z^x Z^z & & Z^x Z^z & & Z^x Z^z \\ F_D(w) / w / z & & F_C(w) / w / z & & F_B(w) / w / z & & F_A(w) / w / z \\ 1 & 1 & & 1 & 1 & & 1 & 1 \end{matrix}$$

Q/ MÿD Fû ?Q/MQiv xBbFm DbQm iviQ M2`QpMQbiB Qbi`ûX S  
 p2HB (BM= 1;1- (1) = 1;465- (1) = 1;6275 1( .) = 1;72 D2 bTHMÿM i Fû  
 TQ/KQMF

$$1( .) 1( *) 1( -) 1( ):$$

kXjX ahP\* > ahA\*E • .PJAL L\*1 hû1hP>P ahISLp

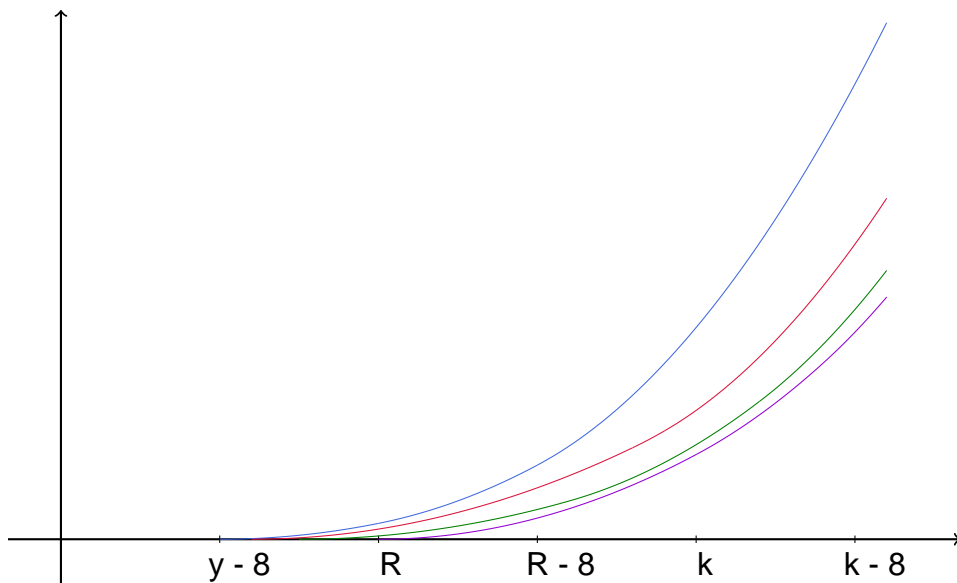

P#`€x2F kXRR, AMi2;`€H D FQ 7mMF+2 ?Q`MQ K2x2 x /Bbi`

EQKQ/Bii2/v /QKBMmD2 biQ+? biB+FQm /QKBM M+Q iü2iQ?Q b  
 FQKQ/Biv- FQKQKBMmD2 biQ+? biB+FQm /QKBM MAQBü2iQ?Q bir  
 FQKQBB/QKBMmD2 biQ+? biB+FQm /QKBM M+AQ iü2iQ?Q bimTMÿ

A T`Q biQ+? biB+FQm /QKBM M+B iü2iQ?Q bimTMÿ 2tBbimD2 Hi  
 M iBpMQ /2}MB+2 mp2/2Mû MQ^2 D2 i Fû HûT2 pB/ÿi- ^2 `Qx?Q/Qp  
 /QKBM M+2 iü2iQ?Q bimTMÿ K€ p2`xB F2 x`mBMQp€MQX hQ b2 T  
 HBx +B xpQHQ x M€?Q/Mw+? T`QKÿMMw+? M2/QKBMQp Mw+? biQ  
 bimTMÿ iv M€?Q/Mû T`QKÿMMû- Fi2`û K DQ FH /MÿD Q BFKQbiX  
 T`QKÿMMû- Fi2`û K DQ FH /MÿD Q BFKQbiX

oÿi eXRL€?Q/M€ T`QKÿMMû- Fi2`û K DQ FH /MÿD Q BFKQbiX  
 KBM M+Q iü2iQ?Q bimTMÿ i2?/v D2M i2?/v F/FH F/MQmmT`BpiMQp€  
 /2`Bp +Q- x€TQ`MQm /`m?Qm /2`Bp u0Q 0-Fpk 0MQm0iü2iQ?Q bimTMÿ

$$1 u( ) \quad 1 u( )$$

2tBbimD2 H2bTQš D2/Mu0 -mF iBzi€Qip €û7lnTMFS+r2D2 TQ/KQMFv iwF D  
 /2`Bp +Q- u0Q 0-Fpk 0MQm0iü2iQ?Q bimTMÿ 0V- T`Q Fi2`Qm D2 i iQ M2`QpMQbi Qbi`€

$$1 u_0( ) > 1 u_0( ) :$$

SQ/Q#Mÿ D FQ m biQ+? biB+Fû /QKBM M+2 /`m?û?Q bimTMÿ Db  
 iB+Fû /QKBM M+2 iü2iQ?Q bimTMÿ M2Kmb2HB TQ`QpM€p iDB`/Q  
 M€bH2/mDQ+Q pÿi X

oÿi dXRL2+?# DbQm M€?Q/Mû T`QKÿMMûX .QKBMmM€@Q/HB M€?Q/  
 MQm T`QKÿMMû- Fi2`û K DQ FH /MÿD Q BFKQbiX biB+FQm /QKBM M+Q 2`m?T`QKÿMMû- Fi2`û K DQ FH /MÿD Q BFKQbiX  
 i Fû biQ+? biB+FQm /QKBM M+QVix2iQ?Q bimTMÿ U

Re





kXjX ahP\*> ahA\*E•.PJAL L\*1 hû1hP>P ahISLp

L FQM2+ x#wp€ mF€x i- ^2 D/2 Q i` MxBiBpMQ3`2H 3BЖ Sü2/TQF  
JmbQ i2/v TH iBi

$$\begin{matrix} Z^x Z^z & & Z^x Z^z & & Z^x Z^z \\ F(w) /w /z & & F(w) /w /z & & F(w) /w /z \quad 8x2 R: \\ 1 \quad 1 & & 1 \quad 1 & & 1 \quad 1 \end{matrix}$$

S`pMQ TQ/KQMF biQ+? biB+Fû /QKB3M D222ü2 bCTHMÿ Mn XMyTü2 /  
TQFH /m THvM2 2tBp-iøM F22`ûK TH iQ

$$\begin{matrix} Z^0 Z^z & & Z^0 Z^z & & Z^0 Z^z \\ F(w) /w /z < & & F(w) /w /z & & F(w) /w /z; \\ 1 \quad 1 & & 1 \quad 1 & & 1 \quad 1 \end{matrix}$$

D2 i2/v bTHMÿM B /`m?€ TQ/KQMF biQ+? biB+5ûXCKBM M+2 iü  
F€x€MQ i` MxBiBpBiv D2 TQiü2# D2 iÿ mF€x i- ^2 D2 bTHMÿM  
?Q/MQivX

$$1( ) \quad 1( ) \quad 1( ):$$

C F D2 pB/ÿi- B i iQ TQ/KQMF D2 bCTKMÿM D-2i bFQ+?2 biB-2FQm /QK  
iü2iQ?Q bD2TMÿBbvK2i`B+F€- MiB`2~2tBpMQ B i` MxBiBpMQ- i F  
Í€bi2ÍMû mbTQü€/€MQX □

1tBbimDQ B biQ+? biB+Fû /QKBM M+2 pv Q+? bimTši- iÿKB b2  
oQ+2 b2 Ki^2K2 /Qxpÿ/ÿi dMM2#CFM (/ p (

# jX Ì bQp€ QTIBK HBx +2 p /Q

o iûiQ F TBIQH2 bB mF€^2K2 `2€HMQm THBF +B biQ+? biB  
;BbiB+2X "m/2K2 b2 x #wp i9HQ?Qm- D F TQKQ+Q biQ+? biB+  
i` bmX LÿFi2`û TQxM iFv p iûiQ F T B i Q # 22pv2 x € D Q K +(B K Q ? Q  
b2xM€KBi b T`Q#H2K iBFQmX

S`QiQ^2 D/2 Q KBMBK HBx ÍMQ 9HQ?m- #m/2K2 Kmb2i x pû  
/QKBM M+2X

.2}MB+2 L92x ?# DbQm M€?Q/Mû F(x) K G (M) Mûb Qm D2DB+? /Bbi`  
7mMF+2X û2FM2K2- ^2 M€?Q/Mû F(x) K G (M) Mûb Qm D2DB+? /Bbi`  
M€?Q/MQm T`QK`pM M Q K rbim. T Mÿ K D U biHB^2

$$F(x) \quad G(x) \quad 8x^2 R$$

$$F(x) > G(x) \quad T`Q \quad Mÿx^2 R:û$$

h iQ /2}MB+2 biQ+? biB+Fû /QKBM M+2 b2 Q/ /2}MB+2 T`Q  
p Q`B2Mi +B M2`QpMQbiQX

L` QK 9FQH2K #m/2 pv#` i x K M K Q D B 2 M M p M 2 D H 2 F Q X \*2biv x  
K #m/Qm KQi M€?Q/Mû /Q#v D2DB+? mbFmi2ÍMÿMQX E`QKÿ iG  
K HBxQp i Í b bi`€p2Mw M +2biÿ- #m/2K2 b2 i Fû bM ^Bi/Q` x  
TQ/Q#MQbiQX C2 H2`Qx/QH- D2biHB +?+2K2 /Q` xBi pí b M  
TQ?QpQ`X SüB +2biÿ M M€FmT M2MQ TQ/bi iMû- D2biHB b2 x  
p m D 2 K 2 M T` +QpMQ TQ?QpQ`- /Q` xQK2 b /Qbi i2ÍMwK Tü2/b  
T` p/ÿTQ/Q#MQbiQ TüB HB pí bX hviQ 9HQ?v i2/v #m/Qm x€pB  
`wK #m/2K2 MÿD FwK xTibQ#2K m`ÍQp i/iH2^BiQbi pí bMû?Q T

## jXRX S` p/ÿTQ/Q#MQbi pí bMû?Q TüQD2x/

S`pMQx TüQbimTi D2 TQmx2 K tBK HBxQp iT` p/ÿTQ/Q#MQ  
Í B X ov#2`2K2 bB i2/v i F Q p Q m € + F M p D pÿi Q /Bbi`B#mÍMQ 7m

$$p_{hs}(T) = K \ t \ F(T)$$

.QHMQ BM/2t PhS D2 F M Q ; H B K + F S ? Q # # B H B i v  
1FpBp H2MiMQ F iQKmiQ TüQbimTm D2 KBMBK HBxQp i/Q#  
/Q#MQ ü Q D 2 x /m pí bX "m/2K2 i2/v KBMBK H B F x Q p ü i Q p H M i B H Q  
F / Mû /Bbi`B#mÍMQ 7mMF+B p X € K B xpQH2MûK #Q/ÿ

$$shh( ) = K B M ^1( )$$

.QHMQ BM/2t Shh D2 x M; H B + F 2 M Q B Q 2 M h K p M Q h B K 2  
S`BMS B T 2 MiBH2 iD p 2 F Q p v 2 ^2 xpQH2K(Q; T T Q K / 2 i Q ? Q - D F  
KQ+ D2 T`Q M€b /iH2^Biû /Q` xBi pí bX ÌQK D2 iQ Tx p Q M € K 2 i X i 2  
SQiQK #m/2K2 m F ^/û x +2 b 100 m p W Q p 2 D D 2 M P H 2 D Q +? b j X X M € ü i -

jXRX S\_ o.þSP.P"LPah oì aLú>P SûPC1w.l

SQÍQi HB #v+?QK i2/v M TüQFH / b2 b+ûM€üB b KQ`MwK- biü2/MC  
Up ;` jXK Q/ü2V- H2 M2TQÍQi HB #v+?QK M TüQFH / b2 b+ûM€ü2  
F H KBi - Fi2`€ Q+?`QKBH /QT` pm p ì2bFû`2Tm#HB ;Xx í€iF2K T  
.€H2 b2 TQ/Qp€K2- D F /HQm?Q #m/2 +2bi i`p i- TQFm/M bi M2 M  
b+ûM€üiX hQK xDBb<sub>sh</sub>QK M2Q/MQixh2MiQ TQbimT T`Qp2/2K2 T`Q F  
M FQM2+ pv#2`2K2 im- Fi2`€NKZED?K/MQixh

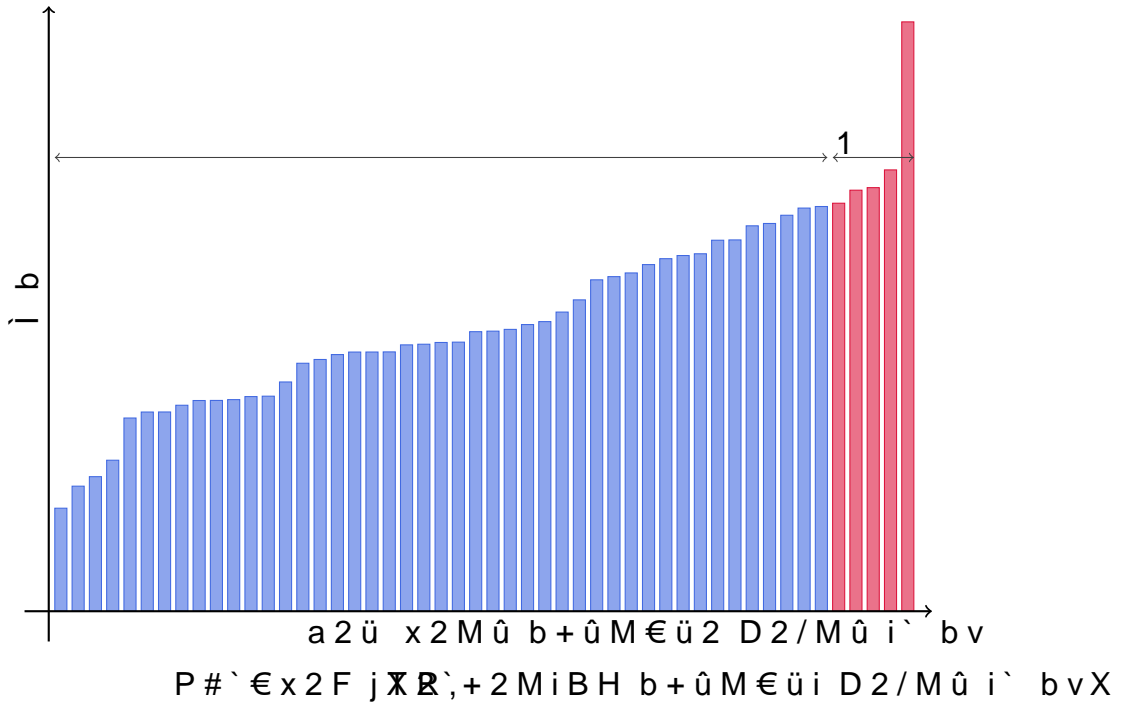

SüQFH TMBFmDK2 K2iQ/m PhS M FQMF`ûiMQ TüQFH /X "m/2K2 p  
KQ/`û i`Fbví2`p2MûG` tpVx ;jXK  
L2DT`p2 #m/2K2 +?iQi /Q` xBi x 98 KBMmiX SQ`QpM€K2 i2/v /B  
i` b p í b2 98 KBMmi pv#2`2K2 im pÿi Q,

$$p_{hs}(45) = K t F(45); G(45) = K t 0; 0,6g = 0; 8:$$

hQ?QiQ K tBK y-3 M #wp€ /Bbi`B#m íMxSQFMF+b2BKQ//v`û p`QbVQK2 in  
i` bm- /Q +QH2 /Q` xQK2 p í b b T` p/ÿTQ/Q#MQbiQ y-3X SQFm/ #  
x R8 KBMmi- xpQHBHGBX#v+?QK i` bm

$$p_{hs}(b) = K t F(15); G(15) = K t 0; 0,3g = 0; 3:$$

C F D2 pB/ÿi- QMB@mBK2QT`D2`/#B2`Bbi€ pQH#TX ` K2i`m  
S`QÍ DbQm Q# TüQbimTv 2FpBp H2MiMQ\ o TüQbimTm PhS D  
p2 Fi2`w DbK2 +?iÿHB /QD2i Uiü2# 98 KBMmiV pv#` HB DbK2 M2  
7mMF+Q Ui iQ ?Q/MQi M€K pv H y-3VX S`QiQ^2 /Bbi`B#m íMQ 7r  
FQM2ÍMm DbQm D2DB+? ?Q/MQiv R- Q#ÿ /Bbi`B#m íMQ 7mMF+2 K  
M #wp i ?Q/MQiv y-3 M2#Q pQ+2X Jv bB pv#2`2K2 im /Bbi`B#m íMQ  
M #m/2 /üQp2X

ky

P#`€x2F jXk, ow#ÿ` M2DH2T` Q2MiB+ü2Mi€ü2/HQipFKQ p€ F H KBi k  
 p "` MÿRX

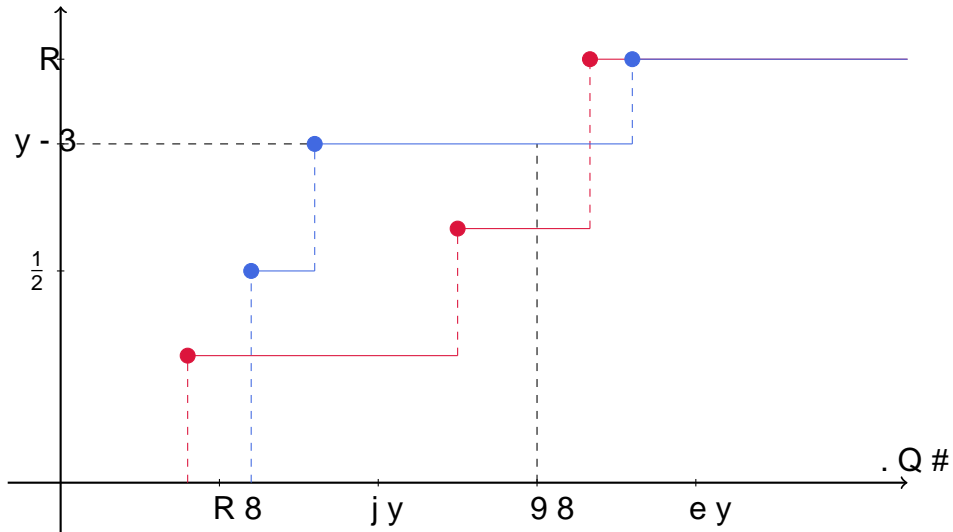

P#`€x2F jXj, .Bbi`B#míMQ 7mMF+2 TQ`QpM€p Mw+

.`m?wK TüQbimT2K #m/2K2 +?iQi /Q` xBi +Q M2D/üQp2 b T`  
 M€MQK Fp MiBHQPw+? 7mMF+Q xQbF€K2

$$s_{hh}(0;8) = KBM^{-1}(0;8); G^{-1}(0;8) = KBM^{-1}; 50 = 24:$$

wpQHqK2 bB F2-/TìQibm2 b T` p/ÿTQ/Q#MQbiQ Ny W /Q` xQK  
 KBMmi UQT` QiB 8y KBMmi€KX TFu€XTHB DbbK2 i2/v- ^2 pv#Q`€K2

jXRX S\_ o.þSP.P"LPah oì aLú>P SûPC1w.l

K€ M2DH2`Q2MiBHX ÌQK KûMÿ M€K x€H2^Q M pí xpMCHKQTüQ D2x/  
iQK KûMÿ M2DH2T Q+? i` b #m/2K2 xp ^Qp jhh( #X/S`Q €K F/22b i E  
Q T2`+2MiBH í bm i` bvX

C2 iÿ x#wp€ mF€x iP M @FiBQD KÿQ \$2#B-BiB H2 i`b Q2Hp BBKQ2 b2  
biQ+? biB+FQm /QKBM M+QX

oÿi N(X)h` b Qbiü2 QTIBK€HMQ p2 bKvbHm PM@iBK2 T`Q# #BHBiy  
iBK2V p MÿD FûK 2bb2X T`Q MÿD FQm TV MÿM/Q#KVBQp M€ biQ+?  
iB+FQm /QKBM M+Q T`pMQ?Q bimTMÿ ^€/MQRpD BÍM€ rB KTHBF r x X M  
Q#2+Mÿ M2TH iQX

.iF xX2+?#D2 QTIBK€HMQ P M@biB K2HTi X #Q# B MBK2 M€- ^2 p MÿD Fû  
Í b2 M #wp€ /Bbi`B# rí(M)Q Qbmü2FM 2Dpv Q ?Q/MQK X x2 p 2+? i` b

$$F(T) > K_t F_{\#}(T); 8\#2 K n f g \quad T`Q MÿD Fû$$

hQ D2 2FpBp H2MiMQ b2 x€TBb2K

$$F(T) > F_{\#}(T) \quad 8\#2 K n f g \quad T`Q MÿD Fû$$

h iQ bFmi2ÍMQbi pvHmímd2 biQ+? biB+FQm /QKBM M+B T`pMQ?Q  
PT ÍMQm BKTHBF +B pvp`€iQK2 T`QiBTüQFM h2KXjÿ2DK2 iüB +  
i`p iRy KBMmi b T` p/ÿ3T/Q#QMKQbKQ Mmi b T` p3/ÿ TQb Q#M2QbiQ  
i`p i8 KBMmi b T` p/ÿ3T-QM Q#Q M8 KB Mmi b T` p3/ÿ TQF Q#M2QbiQ  
#m/2 i`p iR8 KBMmi b T` p/ÿTQ/Q#MQbiQ RX

C2 pB/ÿi- ^2 iM2MQ /QKBMQp M€ biQ+? biB+FQm /QKBM M+Q  
i` bQmMB i` bQm2 p ^€/MûK í b2 M2MQ Qbiü2PMT@BiB K Z M QQ#2 #BKHBH  
pBx ; jXØ

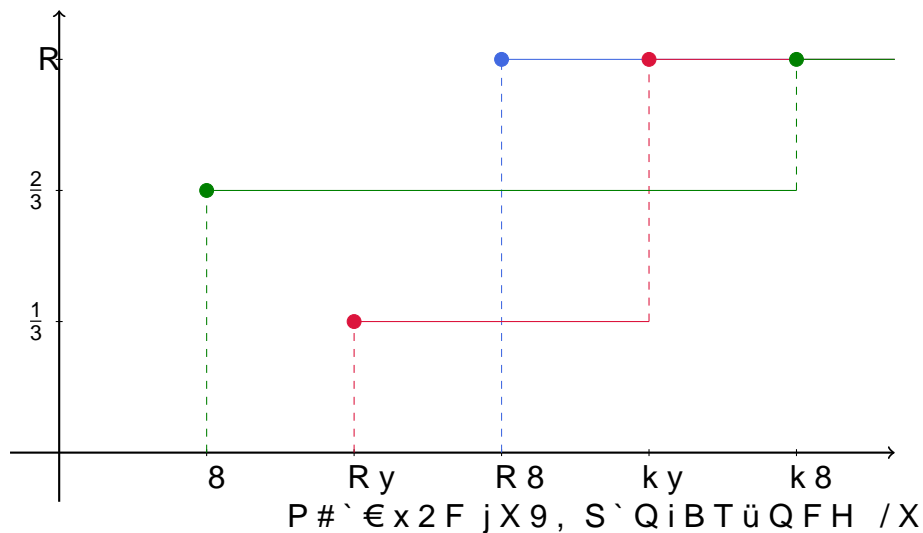

□

.QFv Tü2/+?QxQ pÿiÿ i2/v M2KmbQK2 TQ`QpM€p ip 2+?Mv +2biy  
i` bv M2/QKBMQp Mû DBMwKB i` b KB biQ+? biB+FQm /QKBM M+  
pv#Q` i QTIBK€HMQP+M@iiBKQ KQGSQ #2IMBBH2 iX p2H iBK2

kk

.2}MB+2L82+?# DbQm M€?Q/Mû F(w)KG(M)MD bQm D2DB+? /Bbi`  
 7mMF+2X û2FM2K2- ^2 M€?Q/M+ T`QKÿMMQEKBMmD2 p KBMBK  
 M€?Q/MQm T`Q/KÿMMQm imT`MÿK- D2biHB^2

$$\begin{aligned} & \begin{matrix} Z^x & & Z^x \\ F(w) /w & & G(w) /w \\ 1 & & 1 \end{matrix} \quad 8x^2 R \\ & \begin{matrix} Z^x & & Z^x \\ F(w) /w > & G(w) /w & T`Q MÿK- D2 R:û \\ 1 & & 1 \end{matrix} \end{aligned}$$

## jXkX Ì bQpw `QxTQÍ2i M +2bim

.`m?Qm K2iQ/Qm- Fi2`Qm b2 #m/2K2 p iûhQ pF2 H B BK2 X#xm #;w j  
 h iQ K2iQ/ bTQÍQp€ piQK- ^2 #m/2K2 KBMBK HBxQp iHBM2€`  
 bKÿ`Q/ iMû Q/+?vHFv M€?Q/Mw+? T`QKÿMMw+?X

$$h_h^*( ) = KBM( ) + \frac{p}{o} ( )^o$$

C/2 i2/v Q bQmÍ2i biü2/MQ ?Q/MQiv Í bQpû `2x2`pv x€pBbHû M  
 +2biv xpQH2MûK FXL2}F`B2MQm Q?H2/ #v b2 KQ?HQ x/€i- ^2 ÍQK  
 iQK pQ+2 b2 pv?w#€K2 `BxBFm pQHqK2 i2/v TQ/H2 biQ+? biB  
 L2MQ iQKm H2 i FX

SüQFHIFXK2 bB iQ M FQMF`ûiMQK TüQFH /mX "m/2K2 pQHB  
 Up ;` 7x8 KQ/ü2V Ki^2 b2 bi2DMQm T` p/ÿTQ/Q#MQbiQ i`p i R8  
 .`m?€ +2wip ;` 7x8 p2MÿV Ki^2 b2 bi2DMQm T` p/ÿTQ/Q#MQbi  
 98 KBMmiX

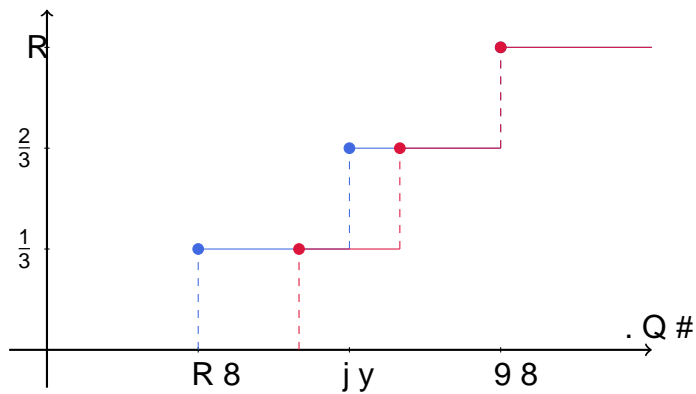

P#`€x2F jX8, .Bbi`B#mÍMQ 7mMF+2 TQ`QpM€p Mw-

aiü2/MQ ?Q/MQiv iÿ p(?) Q302KB Mh(Q)=35 KBMmi D2DB+? bKÿ`Q  
 Q/+?vHFv D b(Q) 12;25 p o ( ) ÷ 8;16X hvIQ ?Q/MQiv /Qb /QK2 /Q  
 T`Q pwTQÍQÍ2H iBK2X#m/;2i

$$\begin{aligned} h_h^*( ) &= KBM( ) + \frac{p}{o} ( ); 1( ) + \frac{p}{o} ( )^o \\ &= KBM + 12;25; 35 + 8;16g \end{aligned}$$

jXjX ahû1.LP Ì aPo• \_1w1\_o

Sü2biQ/QKBMmDQ+? biB+FQm /QKBM M+Q T`pMQ?Q bimTMÿ U i  
/QKBM M+Q /`m?û?Q bimTMÿV- T>Q122bBQQKQ`pQ12iiBk2 #m/;2i  
xpQHqK2+2bQimQ^2 K2M Q `QxTIVuH2P€QQYki2Q Q biü2/MQ ?Q/MQim

\_Qx?Q/Qp i2H- Fi2`w pQHqP22HiiBk2Q#mQ#Q B^ M2MQ M2M bviMw

jXjX aiü2/MQ Í bQp€ `2x2`p

L FQM2+ b2 #m/2K2 x #wß MK2ti+Q/Qmi` p2HhBkX oxQ`2+ pvT /€  
M€bH2/QpMÿ

$$J_{1hh}(\ ) = KBMF^{-1}(\ ) + \frac{1}{1} \int x F^{-1}(\ ) f(x) /x ;$$

F/T D2 Í b- p2 Fi2`F(K)≠H-iiQ/v Í b- p2 Fi2`w m^ #m/2 +2bi DBbiÿ /Q  
F^{-1}(\ ) D2 Fp MiBHQP€x7mMFiq T` p/ÿTQ/Q#MQbiBX

C2 pB/ÿj2^M 2t+2bb i` p2H CBK2Sü2`M2MkiBH2 i` K B M BkK B Bxm @  
D2K2 M2D2M Fp MiBHQP+QmbQmMFi+BiQ Fp MiBHQPû 7mMF+2 b BM  
K€ x 9FQH xM2pw?Q/MBi+2biv b` BxBF2K TüQHB p2HFû?Q xTQ`/  
TQ/`Q#MÿD2XTQmx2 FQ2}+B2Mi m`ÍmDQ+Q p€?m Bmi2;`€Hm p bQ  
TQFmbQK2 B2QIQX2b

$$\int_{F^{-1}(\ )} x F^{-1}(\ ) f(x) /x = \frac{u = x F^{-1}(\ ) \quad u^0 = 1}{v^0 = f(x) \quad v = F(x)} =$$
$$= \int_{F^{-1}(\ )} x F^{-1}(\ ) F(x) \int_{F^{-1}(\ )} F(x) /x$$

.Qb x2MQK /Q T`pMQ?Q ÍH2Mm xQbF€K2

T F^{-1}(\ ) F(T) F^{-1}(\ ) F^{-1}(\ ) F(F^{-1}(\ )) = T F^{-1}(\ ) 0 = T F^{-1}(\ ):

ov HQ M€K i2/v- ^2 Bmi2;`€H p2 pxQ`+B J1hh D2

$$\int_{F^{-1}(\ )} x F^{-1}(\ ) f(x) /x = \int_{F^{-1}(\ )} T F^{-1}(\ ) F(x) /x:$$

SQ/Qp2DK2 b2 M imiQ ?jQXM QimF H^(\ ) mü2/bi pmd2 THQ+?m Q#/Ü  
MQFmK2(x)B T b pw FQm RX P/ MÿD Q/2Íi2K2 F(K)U p m TjQm FÜBpFQR  
KQ/ü2V xDBbiQK2- ^2 TipQ/MQ Bmi2;`€H Tü2/bi pmd2 THQ+?m M  
F(x) Up ;` 7m ^HmiÿVX

oÿi Ry(x) S`Q F ^/QtBbimD2 x`KbMQ^BMv p 2+? TüQTmbiMw+? i` b-  
/QKBMQp M€DBMQmi` bQmbiQ+? biB+FQm /QKBM M+Q T`pMQ?Q  
J2 M 2t+2bb i` p2H iBK2X

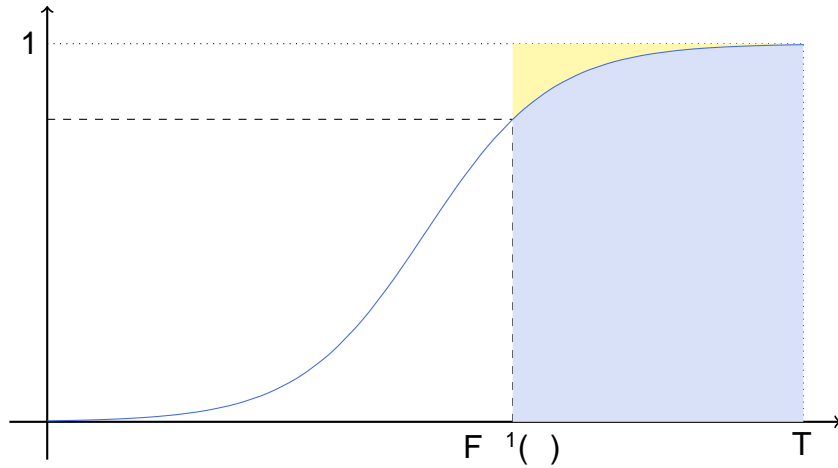

P#`€x2F jXe, owxM KJ2MM22`€2lrbpi` X2H iBK2

.iF xS ü2/TQFH€ /2DK2D2 Q+2B K€HMQ p2 bKvbHm J1hh D2 /QK  
biQ+? biB+FQm /QKBM M+Q TVXMPQ MQÍKi2mTMÿ U

$$() = F^{-1}() + \frac{1}{F^{-1}()} \int_{F^{-1}()}^T x F^{-1}() f(x) /x;$$

$$() = F^{-1}() + \frac{1}{F^{-1}()} \int_{F^{-1}()}^T x F^{-1}() f(x) /x;$$

S`QiQ.^2 - KmbQ T`Q FTH/ F1() F^{-1}() KmbQ 2tB`biQpû-  
^2 F^{-1}() < F^{-1}() X

.€H2 T`QiQ.^2 Tü2/TQ D2€Q€K€2IMQ p2 bKvbHm J1hh- TH i

$$0 \quad () \quad () = F^{-1}() F^{-1}() + \frac{1}{F^{-1}()} \int_{F^{-1}()}^T x F^{-1}() f(x) /x$$

$$\int_{F^{-1}()}^T x F^{-1}() f(x) /x :$$

LvMQ KQ?Qm M bi i /p TüQT /vX

A€^{-1}() = F^{-1}()

o iQKiQ TüQT (/ÿ b2() xD2/MQ/m Q M

$$() \quad () = \int_{F^{-1}()}^T F(x) F(x) /x;$$



jXjX ahû1.LP ì aPo• \_1w1\_o

H2 T`Qi.Q^2 TH iQ T`Q F(x)û F(x) 0- i2/v i2MiQ B Mi2;`€H KmbQ ;  
M2x€TQ`Mw xQbF€p€K2 bBim +B

$$0 \quad ( ) \quad ( ) = \int_{F^{-1}(x)}^{T} F(x) - F(x)/x \quad 0:$$

w iQ?Q TH(v)M2 ( )=0- i2/v( )= ( )X L HB DbK2 i2/v M2/QKBMQp  
i`bm Fi2`€ D2 QT iBK€HUM2QMp2tb2bbHm2H iBK2

A F X^1( ) > F ^1( )

h2MiQF`€i b2 M€K`Q(x)Q H2x D2/MQ/m Q KmbQK2 TQbimTQp i D  
F ^1( ) F ^1( )`Qx Q#QK2QbF€K2

$$( ) \quad ( ) = \frac{1}{1} (1 - ) F ^1( ) - F ^1( ) + \int_{F^{-1}(x)}^{T} x F ^1( ) f(x)/x - \int_{F^{-1}(x)}^{T} x F ^1( ) f(x)/x :$$

C F m^ DbK2 bB mF€x HB- Q# B Mi2;`€Hv Tü2/bi p mDQ THQ+?m M  
bB i Fû Ki^2K2 Tü2/bi pBi D FQ THQ+?m X C/ F Q(Q#FûH)MQF b /ûHF  
1 X

IF ^K2 bB iviQ THQ+ jXd Fi2`w xQ#` x mD2 M B bBim +BX CbQm p  
i`B#m íMQ Fm MQ+2F í2`p2MÿX AMi2;`€H M //B bD2Bx#VhÉ MQ` MÿM F+  
KQ/ü2- B Mi2;`€H M //B biíB #p2 íMQ Q#MÿH+MQ F TÿFMÿ x T /€ K2xB  
/ÿi- ^2 bQm í2i í2`p2Mû ^Hmiû THQ+?v D2 pÿi Q M2^ KQ/`€ THQ+?  
xM KûMFQX

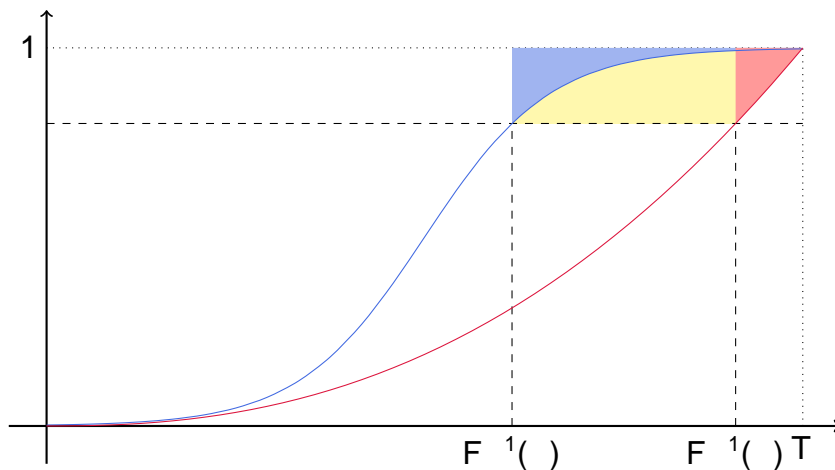

P#`€x2F jXd, owxM K B2MM22t€2lrbp` 2H iBK2

hQK DbK2 H2 /Q HB F2 bTQ` m2bvTM2MQQ QFiBK€HJM2QMp2 bKvbH  
2t+2bb i` p2 MiBK2 DbK2 H2T Q i`bm- Fi2`€ M2MQ /QKBMQp M€bi  
T`pMQ?Q bimTMÿX □

ke

# 9X THBF +2 p ; ` 7Qpw+? 9HQ

SQ/Qp€K2 b2- D F b2 /€ biQ+? biB+F€ /QKBM M+2 D2/MQ/r  
x i2Q`B2 ; ` 7i b TQKQ+Q pwTQÍ2iMQ i2+?MBFvX E iQKm H2 TQ  
Tb ixD2/MQ/m 2Mw EmQbK) M2QpH2Q/ M2 (QTiBK€HMQ?Q ü2 2  
Qbi iMQ ü2 2MQ biQ+? biB+FQm /QKBM M+Q T`pMQ?Q bimTMÿ  
DBKFv TQmx2 p2e) MxM+Q+Q (THBF +2 biQ+? biB+Fû /QKBM M-  
Ki^2i2 M DFQ)Xp (

## 9XR X JQ/2H

L2DT`p2 xKBšK2- +Q #m/2K2 +?i Q) iQKbiQ iKQ'/H2H2K2 (?H2/ i C  
K€HMQ ü2 2MQ 9HQ?v- Fi2`û /QKBMmD2 biQ+? biB+FQm /QK  
/üQp2 xpQH2Mû TüQTmbiMû ü2 2MQ / Mû 9HQ?vX E pbimTMQK  
B TüQTmbiMû B2 B2 iM QûKm #m/2K2 ?H2x dT) H2T Q ü2 2MQ

JÿDK2 `Qx?Q/Qp +QxT` QKQMMQKÿMM€ Ki^2 #wi Q#2+Mÿ bF  
M2#Q pQ+2`QxKÿ`M€ K iB+2X ^ b2 x ÍM2K2 x #wp i ; ` 7QpwK  
Íip2`+Qp€ K iB+2 bQmb2/MQbiBX w iQK #m/2K2 T`Q xD2/MQ/  
xi; i2I - F/I2D2 BM/2tQp€ KMQ^BM X

.€H2 KÿDK2 FQ) +B2; Mi2 U- F/D2 KMQ^BM p 2+? b+ûM€ü  
KQ?Qm M bi iX w/i` xMÿK2- ^2 b+ûM€ü2 DbQm M bQ#ÿ M2x€pB  
#v+?QK +?iÿHB TQÍQi i B b FQK#BM +Q /pQm b+ûM€üi- Kmb2H  
D FQ MQpw b+ûM€üX

SQiQK 9Í2HQp€ 7mMF+2 T`Q KBMBK HBx ÍMQ 9HQ?m #m/2 p

$$\begin{matrix} X \\ KBM \\ c_{ui} X_j : \\ i2I; \\ u2U \end{matrix}$$

PT`QiB /2i2`KBMBbiB+Fû 9HQx2 HB9R) €2MQ?mQ2TK Q b'í QiQipM2M  
Tü2b p 2+?Mv `Qx?Q/Qp +Q T`QKÿMMû- H2 i Fû Tü2b p 2+?Mv

S`pMQ TQ/KQMF #m/2 Q#2+M€- #m/2 K2 Q2 /2QpQi- Mû?Q  
QTiBK HBx ÍMQ 9HQ?v TQFm/ TQ `Qx?Q/Qp +Q T`QKÿMMû M  
MÿD F QK2x2M€- #v D2DB+? bQmÍ2i #vH `Qp2M MÿD Fû ?Q/I  
QK2x2MQ /Q iûiQ TQ/KQMFvX

#v+?QK ?H2/ HB TQmx2 QTiBK€HMQ ü2 2MQ /QKBMmDQ+Q  
iB+FQm /QKBM M+Q T`pMQ?Q bimTMÿ- #m/2K2 TQ^ /Qp i bTHM

$$\begin{matrix} X & X \\ c_{ui} X_i & g P_u \\ i2I & 2U \end{matrix} \quad 8u2U;$$

F/P D2 T2`Kmi ÍMQ K iB+2X

$$g = \begin{matrix} c_{X0i} \\ i2I \end{matrix}$$

D2 +2M TipQ/MQ?Q ü2 2MQ iB+2vTjMjEujBD2 i Fû `Qx?Q/Qp -  
T`QKÿMM€X wKBšK2- ^2 TQFm/ #v b2 D2/M HQ Q K tBK HBx ÍM  
QT ÍMw bvK#QH M2`QpMQbiBX

9XkX :\_ 6u

SQ/Qp2DK2 b2 M pwxM Kiÿ+?iQ TQ/KQM2FX L H2pû bi` Mÿ K€  
TüB xpQH2MûK L+ûTM €ûBbi` Mÿ bíQ Q€iKwüEü2B T2`Kmi ÍMQ K iB+2  
bQ#2Mw +2HFQpQm +2MQxm TüQ/HMq MQ m2D2MMQ iHBpûKm bHQmT  
K iB+2X SPQD2T2`Kmi ÍMQ K iB+2- #m/2 T`€pÿ D2/2M x2 bíQi M+iM  
TQ^ /mD2K2- #v pwbH2/M€ +2Mu #vüHB FK2Mü QbM+2#M€ üBpM pwbH2/M  
TipQ/MQ?Q ü2 2MQ TüB MíSDQF QK2B BT2M K2nB ÍMQ K iB+2- M2KQ?Qm  
iviQ b+ûM€TüFQp iX

C2/MQm pÿiQm, SQ^ /mD2K2- #v 2tBTbiQ p iB` Qm` K2nB F2^/ûK b+0  
M€ü BTHMÿM TQ/KQMF - ^2 +2HFQp€ +2M MQpÿü ND2H22MMQ?Q ü2  
M2#Q`QpM +2HFQpû +2Mÿ TipQ/MQXQ ü2 2MQ TüB b+ûM€üB

oxTQK2šK2 bB M TüQFH / bHv^ übFwKB biü2/BüBxHB B D bÿK2 F  
b/`m^2Mû biA02/Bi2FQ Q/TQpQ/ HQ QT ÍMûKm TQü /Q b+ûM€üiX S2  
KQ/2Hm K€ Tü2bMÿ i2MiQ pwxM KX

w Tü2/TQFH /m- ^2 F ^/w b+ûM€ü K€ bi2DMQm T` p/ÿTQ/Q#MQb  
p H2MiMQ T`pMQ TQ/KQM+2 biQ+? biB+Fû /QKBM M+2 T`pMQ?Q  
biQ+? biB+Fû /QKBM M+2 T`pMQ?Q bimTMÿ m^ i2MiQ KQ/2H M2T  
pQ/MQ ü2 QTMQ K€HMQ p2 bKvbHm biQ+? biB+Fû /QKBM M+2 T`pM  
T2K iQ?QiQ KQ/2Hmx0i-QTQ2b2 Q2M Q2/QKBMmD2 b2#2 b KQX

Ji^2K2 b2 M i2MiQ KQ/2H TQ/Qp i B i F- ^2 ?H2/€K2 M2DH2T Q  
^BMv TüQTmbiMw+? ü2 2MQ M2/QKBMQ p iQw? bTBp€ QmQ/QiK2 MMQ  
T`pMQ?Q bimTMÿX hQ Q/TQpQ/€ M€xQ`Mû 9HXQx2Fy/`mQKiE TBiQH  
T`BM+BTm 7mM;mD2 B M€bH2/mDQ+Q KQ/B}F +2 KQ/2HmX

L ?` /QK2@HB T2`Kri ÍM BMQ p2+Bi2`û K€K2 i Fû bQmÍ2i p F ^/0  
ü€/Fm B p F ^/ûK bHQmT+B`Qp2MR- H2 D2DQ?Q/MQiv M2DbQm #B  
h0;li- #m/2K2 iQKiQ KQ/2H2K ?H2/ i ü2 2MQ /QKBM mDQ +BQ+ FQpQ /M  
/QKBM M+Q /`m?û?Q bimTMYF y Bx ;` 7v

h FiQ mT` p2Mw KQ/2H K€ H2 D2/Mm x€b /MQ M2pw?Q/m mT` p  
H2 M2MQ TQbi ÍmDQ+QX;iL2/H2K2MmüQ p2MQ/QKBMQp x0TipQ/MQ ü  
biQ+? biB+FQm /QKBM M+Q /`m?û?Q MB T`pMQ?Q bimTMÿX L /`  
/QKBMmDQ+Q TipQ/MQ ü2 2MQ biQ+? biB+FQm /QKBM M+Q /`m?  
bTHšQp iX

L2^ b2 TmbiQK2 /Q b KQiMû?Q TQÍQi€MQ b ;` 7v- TüBTQK2šK2  
MQbiB ;` 7iX

9XkX :` 7v

.2}MB+2(E)X: ` 72K`QxmKQK2 mbTQü€#(W)Em- /p/QDB2+BQM2ÍM€  
KMQ^BM p`E#Q(i);bg; a€ b; a;b2 Vg DbQm M2Q`B2MiQp Mû ?` MvX

.2}MB+2(F)X`B2MiQp MwK ;` 72K`QxmKQK2Gm-b(V)Ej€F/MQm /pQDB  
D2 FQM2ÍM€ KMQ^BM f(a;b);a€ B;ia;b2 Vg DbQm ?` MvX

o Q`B2MiQp MûK ;` 7m DbQm ?` Mv mbTQü€/ Mû /pQDB+2X C2 i  
x p`+?X/HQmp`+?Q(K;t) 2EV- M2#Q D2byiH€ (Q;x)2xE Vx

.2}MB+2(F)XÿDK2 ;G=7(V;E)X SQFm/ FG;TüBrü /QK2 xQ E! xP-MQ  
ü2FM2KQ-D^2p€^2Mw ;` 7X



9XjX JALAJ•GLP EPah\_ :\_ 6l

2H2Fi`B+Fû p2/2MQ +Q M2DF` i QX h2MiQ 9FQH pvü2 BH Pi F ` "Q  
Kmb Tm#HBFQp H D2D p `Q+2 RNke- +Q^ D2 bB Ry H2i Tü2/ pxM  
x #wp DQ+Q **BQR**;X7v (

J2xB / H Q KQ^Mû pvm^BiQ KBMBK€HMQ FQbi`v ;` 7m Ki^2 T iüB  
M2#Q F M HBx +Q- pQH# p2/2MQ i` bv K2i` M2#Q M bi pQp€MQ b  
MBF ÍMQ+? i2+?MQHQ;BQ+?- F/v b2 bM ^QK2 x #`€MBi pvipQü2MQ  
T`QTQD2MQ p 2+? m^Bp i2HiX

o TüQFH /mpQH#v i` bv K2i` D2 M€ 9FQH pvipQüBi+Q M2DH2p  
p 2+?Mv bi MB+2X ai MB+2 i2/v #m/Qm p`+?QHv ;` 7m FQbi`m i  
imM2Hv bTQDmDQ+Q bi MB+2X L2mp ^mD2K2 i2/v TüQT /MQm TC  
T`QTQD2MQ D2/MQiHBpw+? KÿbibFw+? Í€biQ x DQK€ M€b TQmX

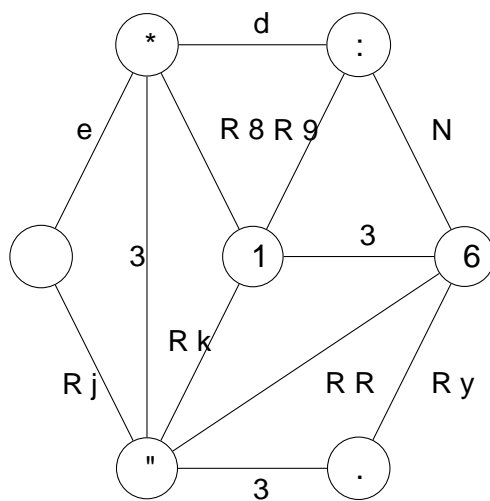

P#`€x2F 9XR, :` 7 x /€MQ /2i2`KBMBbiB+Fû 9HQ?vX

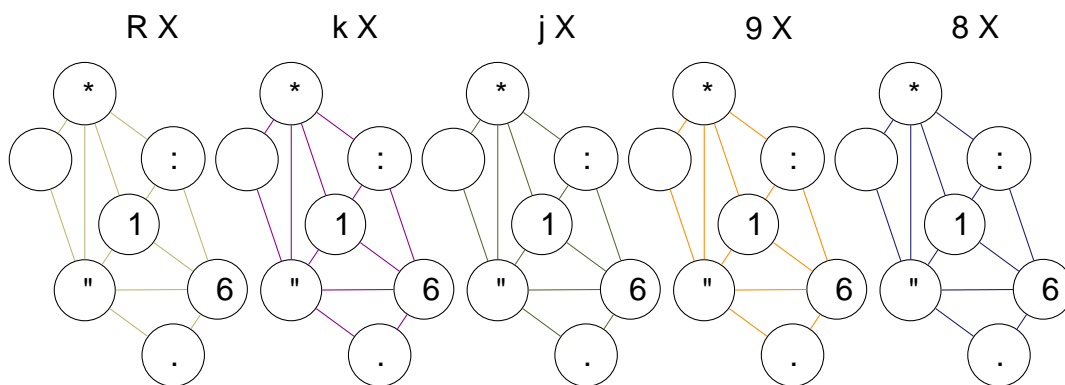

P#`€x2F 9Xk, 8 b+ûM€üi p€^2Mw+? ;` 7i T`Q ?H2/€MQ KBM

L M€bH2/mdQ+Q+? bi` M€+? bB mF€^2K2- D F M DQi KBMBK€  
p +QK D xv+2 Tvi?QM b TQK **BQR** ü2 BÍ 2mñQ Q# BÍ 2MQ p x€FH /MQ  
Tvi?QMm- i F^2 D2 TQiü2# D2D M2DT`p2 M BMbi HQp i TüQF x2K

TBT BMbi HH ;m`Q#BTv

.€H2 D2 TQiü2# M BMbi HQp i KQ/mH LmKTV,

jy

TBT BMbi HH MmKTV

JQ/mH LmKTV`Qx BümD2 K i2K iB+Fû b+?QTMQbiB D xvFm  
^Qp i?H pMÿ T`Q H2T Q T`€+B b K iB+2KBX  
LvMQ b2 Ki^2K2 TmbiBi /Q T`Q;` KmX C FQ T`pMQ KmbQK2 M  
/mHvX L T`pMQ+? /pQm ü€/ +Q+? BKTQ`imD2K2 ü2 BÍ ;m`Q#B-  
T`Q D2/MQ/m Q T`€+B b pQ+2`QxKÿ`MwKB TQHB- M Íip`iûK  
Fi2`û?Q #m/2K2 ;2M2`Qp i b+ûM€ü2- M FQM2+ KQ/mH Bi2`iC  
pvip€ü2i TQi2MÍMQ KMQ`BMmX

R BKTQ`im`Q#BTv b ;T  
k 7`QK;m`Q#BBTKVTQ`i"  
j BKTQ`MmKTV b MT  
9 BKTQ`i M/QK  
8 BKTQ`Bi2`iQQHb

.€H2 x /2}MmD2K2 7mMF+B- Fi2`Qm #m/2K2kp)Xp€ü2i TQi2M  
e /27TQi2M+MBnKMQxBM U Bi2` #H2V ,  
d b 4HB b iBi2` #H2V  
3 i4(Bi2`iQQHb X +QK#BM7 QB`QBMb Ü BMH22M b VYRV )  
N `2im`Bi2`iQQHb X +? BMX7`QKnBi2` #H2UiV

LvMQ x p2/2K2 /pQD`Q`xKÿFIMüüTüH22bi pmD2 K iB+B px/€H2M  
K€K2 M2Q`B2MiQp Mw ;` 7- D2/M€ b2 Q bvK2i`B+FQm K iB+B- p  
Q/TQpQ/€ D2/2M p`+?QHXSQFm/ K2xB /pÿK p`+?QHv M2MQ  
M M2FQM2ÍMQX JmbQK2 p F M bi pBi i FQpû M2FQM2ÍMQ-  
;m`Q#B- T`QiQ TQm^BD2K2 M2FQM2ÍMQ T`€pÿ xTnp`+?Q`QHKQ/  
pHQ`QK2 TQÍ2i p`+?QHi M 2?Q ;` 7mX

Ry BM74:\_"XAL6ALAHu  
RR ;` 7 4 MTX `` vU((y - Rj- e- BM7 - BM7 - BM7 -  
Rk ( Rj- y- 3- 3- Rk- RR- BM7 ) -  
Rj ( e- 3- y- BM7 - R8- BM7 - d ) -  
R9 ( BM7 - 3- BM7 - y- BM7 - Ry- BM7  
R8 ( BM7 - Rk- R8- BM7 - y- 3- R9 ) -  
Re ( BM7 - RR- BM7 - Ry- 3- y- N ) -  
Rd ( BM7 - BM7 - d - BM7 - R9- N- y ) )  
R3 Tnp`+?QH2M4` 7V

C FQ / H Q F`QF x ÍM2K2 pvip€ü2i KQ/2H T`Q pvü2 2MQ /2i  
ü€/Fm i2/v pvipQüQK2 T`€x/Mw KQ/2H M kyX ü€/Fm pvipQü  
tX`Qx?Q/Qp +Q T`QKÿMMû ipQüQ Íip2`+QpQm K iB+B m/€p D  
#Q/v #m/2 M2#Q M2#m/2 ?` M DbQm i2/v #BM€`MQX .€H2 T  
i iQ K iB+2`Qx?Q/Qp +Q+? T`QKÿMMw+? bvK2F BwF€`#?`QHf ^  
ü2FM2K2- ^2 TQFm/ p2Q#?TQMqX KmbQ pûbi i#FQ ?` M Q T FX  
SQbH2/MQ TQ/KQMFQm x F€^2K2 ?` Mv- Fi2`û #v p2/Hv x D2/M  
h2MiQ KQ/2H D2 b2Tb€M MQ^2X

wKBšK2- ^2 +2Mm ?` Mv- Fi2`€ M2MQi pX ;ò F h m M Dbi Kp2QFK 2QNK n  
x p2/HB T`Q B y M / Q F m 2`û DbK2 /Qb /BHB M2F, Q M Q # B Q x FMB ? Q p

9XjX JALAJ•GLP EPah\_ :\_ 6l

$$\begin{aligned}
 & \sum_{i,j=2}^P K B M_{ij} 0;5 c_{ij} x_{ij} \\
 i X \wedge x_{ij} &= x_{ji} \quad 8i; j 2 V \\
 x_{ij} &= 0 \quad 8i 2 V \\
 x_{ij} & 2 f 0; 1g \\
 & \sum_{i,j=2}^P 0;5 x_{ij} \quad j V \quad 8V^0 2 P(V)
 \end{aligned}$$

RN KQ/2HR 4 ;TX JQ/2HU ô w FH /MBnKQ/2H ô V  
 ky t 4 KQ/2HR X //o `b U Tnp`+?QHm - Tnp`+?QHm - pivT24:\_"X  
 kR  
 kk KQ/2HR X //\*QMbi`b U  
 kj Ut(B - D)44t(7Q`BB)M `MU Tnp`+?QHm V  
 k9 7Q`DBM `MU Tnp`+?QHm V V V  
 k8 KQ/2HR X //\*QMbi`b U U7tQ`BBMB)4MU Tnp`+?QHm V V V

E ?H2/€MQ KBMBK€HMQ FQbi`v ;` 7m #v+?QK KQ?HB)T Qm^Qi M  
 M2#Q pw 2 xKQMÿMw "Q`ipFip H;Q`BiKmb- H2 Kv TQiü2#mD2K2 m  
 ;` 7m TQKQ+Q HBM2€`M Q`QBT`@y+KQp€2MQ Q H;Q`BiKmb KQ?HB  
 p i bTQH2ÍMÿ b2 biQ+? biB+FQm /QKBM M+QX E iQKm b2 M€K #m  
 i2`M iBpMQ /2}MB+2 bi`QKmX L€ ;` 7 D2 bQmpBbHw- T`QiQ TüB  
 TQ/KMQ^BMm p`+?QHi TQ/KQMFm- ^2 TQÍ2i ?` M K2xB iÿKBiQ p`  
 ?` MX SQKQ+QnBm MFaK 2K2 p 2+?Mv ?` Mv K2xB p`+?QHv x / Mû T  
 p`+?QHiX hQiQ ÍQbHQ /ÿHQK2 /pÿK - T`QiQ^2 b2 M€K /Q bQm ím x  
 D2/MQm D FQ ?QMTQ /`m?û D FQ ?QaM 6xmM[Fm+2+FTrü B DQK€  
 HBbiX Jv i2MiQ HBbi pvip€üQK2 TüQKQ p2 pQH€MQ 7mMF+2 i F-  
 T`Q+?€x2MQK Tü2b BM/2tv TQKQ+Q +vFHmX

ke KQ/2HR X //\*QMbi`U ;TX [mB+FbmK U tV44Tnp`+?QHm »k•kV  
 kd 7Q`TQ/KMQxBM H B BT Qi2M+MBnKMMQ;2BTM pU+?QHm V V V ,  
 k3 B 7 H2TQ/KMQxBM V=y,  
 kN KQ/2HR X //\*QMbi`U ;TX [mB+QFB B MTUQt/(KBM-QDx B M  
 jy 7Q`DBMTQ/KMQxBM Vhf2M7Q/KMQxBM V•RV

hQKiQ DbK2 M bi pBHB p 2+?M QK2x2MQ- #v M€K KQ/2H ?H2/  
 bQK2 M bi pBi 9Í2HQpQm 7mMF+B- Fi2`€ D2 bQm í2K p ? p 2+? ?  
 üQ+i KQ/2Hm- #v KBMBK HBxQp HX Ji^2K2 m^i2/v M DQi QTIBK  
 KBMBbiB+Fû 9HQ?vX

jR Q#D 4 ;TX [mB+FbmK U ;` 7 (B - D) » t (B - D)fk  
 jk 7Q`DBM `MU Tnp`+?QHm BVB M `MU Tnp`+?QHm V V  
 jj  
 j9 KQ/2HR X b2iP#D2+iBp2 U Q#D - :\_"X JALAJAw1V  
 j8 KQ/2HR X QTIBKBx2UV

jk

9X SGAE \*1 o :\_ 6Pov\*> 8GP>•\*>

AM+B/2MÍMQ K iB+B M H2x2Mû FQbi`v xQbF€K2 x KQ/2Hm M

je `2 b m Hi 4 MTX`2 b? T2 UKQ/2HRX;2i ii`U ö t ö V - U•R -

L H2x2M€ FQbi` D2 xQ#XXx2M p ;` 7m

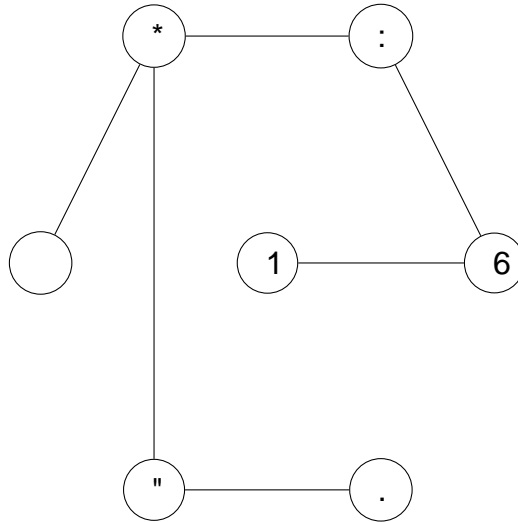

P#`€x2F 9Xj, û2 2MQ /2i2`KBMBbiB+Fû 9HQ?v ?H2/€MQ K

w iQK DbK2 bB mF€x HB- D F TQKQ+Q ü2 BÍ2 ;m`Q#B M DQi  
KBMBK€HMQ FQbi`m ;` 7m- xQbF HB DbK2 iQiQ ü2 2MQX LvM  
FQbi`v ;` 7m b M€?Q/MwK Q?Q/MQ+2MQK ?` M /QKBMmDQ+Qi  
/QKBM M+Q T`pMQ?Q bimTMÿX

E iQKm M2DT`p2 TQiü2#mD2K2 pv;2M2`Qp i M€?Q/Mû b+ûM  
iviQ b+ûM€ü2 K DQ bi2DMQm T` p/ÿTQ/Q#MQbiX ovipQüQK2 i`  
BM/2t m`ímD2 b+ûM€ü- x#vHû /p BM/2tv m`ímDQ ?` Mm K2xB  
MQK2 bQmíi2K ?Q/MQi TipQ/MQ?Q ;` 7m M€?Q/Mw+? ÍQb2H  
;` 7i TQM2+?€K2 yX >Q/MQiv M€?Q/Mÿ pv;2M2`Qp Mw+? b+ûM  
x QF`Qm?H2Mû M /pÿ/2b2iBMM€ KQbi bB ~~KXX~~i2 T`Q?Hû/MQ

IF ^K2 bB pwxM K M€?Q/v M 9HQx2 pQH#v i` bv K2i` X S`p  
Tü2/bi pBi M TüQFH /i F- ^2 x iQK M2T`Q#ÿ?H T`ixFmK TQ/H  
/` ?û #m/2 T`QTQD2MQ D2/MQiHBpw+? /pQDB+ bi MB+- H2 pv

P Mÿ+Q H2T Q TQTb iûiQ M€?Q/MQbiB Ki^2 #wi /€M pw#ÿ  
`QpûK üQx2MQX .2DK2 iQKm- ^2 KmbQK2 T2pMÿ xpQHBi i` bm  
/QxpQK2 pwbH2/2F pw#ÿ`Qpû?Q üQx2MQ- p2 Fi2`ûK K€ F ^/€ }  
9bTÿ+?mX E ^/€ x }`2K M€K p2 bpû M #Q/+2 Tü2/FH€/€ +2Mm  
p Mw+? /pQDB+ bi MB+ Q/ F ^/û }`Kv i2/v xQbF€K2 Q?Q/MQ+  
Tü2/bi pQp i b+ûM€ü2X L QK 9FQH2K #m/2 xpQHBi im M2DH2  
iviQ M #Q/FvX E iQKm TQm^BD2K2 biQ+? biB+FQm /QKBM M+B

"m/2K2 THBFQp iMQ^2 b2Tb Mw KQ/2HX C/2 Q ~~R~~HFF2+B Em  
b2 bFH€/€ x2 /pQm Í€biQX L2DT`p2 TQ/KQMF KB x DBbiQK2-  
;` 7mX .`m?€ Í€bi b2 bi `€ Q biQ+? biB+FQm /QKBM M+BX o 9  
bQmí2i+2M Tü2B2pM2+? b+X M €FQMD2+Qm +2Mv D2/MQiHBpw+? ?`  
b+ûM€üBX



Y	N-ge	R-NR	1	1	1	Y	Rj-9j	d-R9	1	1	1
N-ge	Y	N-j9	RR-jR	R9-NR	R9-R-9j	Y	Rk-83	Y	3-yR	d-NN	3-Nj
R-NR	N-j9	y1	Re-3e	1	8-9y	d-R9	Rk-83	y1	Ry-3d	1	j-jR
1	RR-jR	1	Y	d-NR	1	1	3-yR	1	Y	e-ye	1
1	R9-NR	Re-3e	Y	e-dd	Rk-dy	1	d-NN	1	Ry-3d	Y	Rk-9d
1	R9-eR	1	d-NR	e-dd	Y	Rj-jR	3-Nj	1	e-ye	Rk-9d	Y
1	1	8-9y	1	Rk-dy	Rj-jR	Y	1	j-jR	1	e-ye	N-Rj
											Ry-kk
											Y

Y	Rd-98	RY-Rd	1	1	1	Y	R8-8R	R-8j	1	1	1
Rd-98	Y	Rk-9y	d-8N	Rj-ky	Rk-398-8R	Y	N-9y	N-9y	d-yd	Rj-e9	RR-3R
RY-Rd	Rk-9y	Y	RR-d8	1	k-38	R-8j	N-9y	Y1	Rd-jN	1	8-8N
1	d-8N	1	Y	Rj-3k	1	1	d-yd	1	Y	1	3-jR
1	Rj-ky	RR-d8	Y	9-9d	RR-eN	1	Rj-e9	Rd-jN	Y	8-ed	N-yR
1	Rk-39	1	Rj-3k	9-9d	Y	Rk-38	RR-3R	1	3-jR	8-ed	Y
1	1	k-38	1	RR-eN	Rk-38	Y1	1	8-8N	1	N-yR	Rj-9j
											Y

Y	RY-kR	R-kj	1	1	1
RY-kR	Y	RY-yj	9-Re	N-dd	d-yR
R-kj	RY-yj	Y1	RR-ed	1	N-Nj
1	9-Re	1	Y	RY-j3	1
1	N-dd	RR-ed	Y	9-3j	R9-Rj
1	d-yR	1	RY-j3	9-3j	Y
1	1	N-Nj	1	R9-Rj	d-dy
					Y

h #mHF 9XR, L€?Q/Mÿ pv;2M2`Qp Mû b+ûM€ü2X

$$\begin{aligned}
& \text{KB M } \overset{P}{0;5} c_{u;ij} x_{ij} \\
& \text{a;b2V;} \\
& \text{u2U} \\
& i X \wedge X_{ij} = x_{ji} \quad 8i;j \ 2 \ V \\
& x_{ij} = 0 \quad 8i \ 2 \ V \\
& x_{ij} \ 2 \ f \ 0;1g \\
& \overset{P}{0;5} x_{ij} \ j \ V \} \ 8V^0 \ 2 \ P(V) \\
& ij \ 2V^0 \\
& \overset{P}{c_{ui}x_i} \quad \overset{P}{g P_u} \quad 8u \ 2 \ U \\
& i2l \quad 2U \\
& P \ D \ 2 \ T \ 2 \ ` \ Kmi \ \acute{I}MQ \ K \ iB+2
\end{aligned}$$

jd Tnb+2M `m 48  
j3 ;` 7nb+2M `m 4 MTX x2` Qb UUTnb+2M `m - Tnp`+?QHm  
jN 7Q`b+BM `MU 2nb+2M `m V,  
9y ` M/QKX b22/UV  
9R 7Q`BBM `MU 22W;` 7VV,  
9k 7Q`DBM `MU 2H2W;` 7VV,  
9j B7B54D,  
99 M ?Q/ 4 ` M/QKX mMB7Q`KU•8- 8V  
98 ;` 7nb+2M `m (b+)(B)(D) 4 ;` 7(B)(D) YM ?  
9e ;` 7nb+2M `m (b+)(D)(B) 4 ;` 7(B)(D) YM ?

LvMQ- F/v^ m^ K€K2 pv;2M2`Qp Mû M€?Q/Mû b+ûM€ü2- bTQ  
ü2 2MQ p F ^/ûK b+ûM€üB mHQ^QK2 /Q HBbimX  
hQiQ TipQ/MQ ü2 2MQ #m/2K2 pMQK iD FQT`pQiMQ pQH#m p  
bM ^BiTü2FQM iX

9d +2Mvnb+2MH Brn iM  
93 7Q`b+2MBM `MU 2nb+2M `m V,  
9N +2M 4y  
8y 7Q`BBM `MU 22W` 2 b m H i V V ,  
8R 7Q`DBM `MU 22W` 2 b m H i V V ,  
8k +2M Y4 ;` 7nb+2M `m (b+2M `)(B)(D) » ` 2 b m H i  
8j +2Mvnb+2M `m X TT2M/U+2M fkV

hviQ ?Q/MQiv M€K pv Hv 93-y8- 8j-d9- 8y-jj- 9k-d jd-33X J  
x í HB bFH€/ i KQ/2H- Fi2`wK xQbF€K2 ü2 2MQ b i Q K B M n B D Q Q Q  
/QKBM M+Q T`pMQ?Q bimTMÿX  
h2MiQ MQpw KQ/2H KmbQ KQi p 2+?Mv TQ/KQMFv- Fi2`û KÿH  
9HQ?m bi€H2 b2 bM ^QK2 M DQi bi`QK- i F^2 bi€H2 KmbQ #w

89 KQ/2Hk 4 ;TX JQ/2HU ô JQ/2HnbiQ+? biB+F2n/QKBM M  
88 t 4 KQ/2Hk X //o `bUTnp`+?QHm - Tnp`+?QHm - pivT24:  
8e

9XjX JALAJ•GLP EPah\_ :\_ 6l

8d KQ/2HkX // \*QMbi`bUUt(B - D)44t(D - B)  
 83 7Q`BBM ` MU`Tnp`+?QHmDVB M ` MU`Tnp`+?QHmVVV  
 8N KQ/2HkX // \*QMbi`bUU7tQ`BBM)4MU`Tnp`+?QHmVVV  
 ey KQ/2HkX // \*QMbi`U;TX[mB+FbmKUtV44Tnp`+?QHm»k•kV  
 eR  
 ek 7Q`TQ/KMQxBM H B B Q i 2 M + M B n K M M Q ; 2 B T M p U + ? Q H m V V V ,  
 ej B 7 H U T M Q / K M Q x B M V = y ,  
 e9 KQ/2HkX // \*QMbi`U;TX[mB7+Q`BBM TUQ (KBM Qx)BM  
 e8 7Q`DBMTQ/KMQxBM V H f 2 M T Q / K M Q x B M V • R V

L pQ+ KmbQK2 Tüb/ iMQpQm`QxT? F/Qp€+QnT2TKyMMQp i T2`  
 Kmi íMQ K iB+BX #v QT` p/m HQ Q T2`Kmi íMQ K iB+B- KmbQ #  
 bQmí2i p F ^/ûK ü€/Fm B bHQmT+B`Qp2M RX

ee T 4 KQ/2HkX //o`bUTnb+2M`m - Tnb+2M`m - pivT24:\_"X  
 ed  
 e3 KQ/2HkX // \*QMbi`bU;TX[mB+FbmKUT(B - D)  
 eN 7Q`BBM ` MU`Tnb+2M`m V Q 4 B M ` MU`Tnb+2M`m V V  
 dy  
 dR KQ/2HkX // \*QMbi`bU;TX[mB+FbmKUT(B - D)  
 dk 7Q`DBM ` MU`Tnb+2M`m V Q 4 B M ` MU`Tnb+2M`m V V

C FQ TQbH2/MQ TQ/KQMFm /Q KQ/2Hm Tüb/€K2 TQ/KQMFm biC  
 X X  
 C<sub>ui</sub>X<sub>i</sub> g P<sub>u</sub> 8u 2 U:  
 i2l 2U

dj KQ/2HkX // \*QMbi`bU  
 d9 ;TX[mB+FbmKU;`7nb+2M`m(mR - B - D)»t(B - D)  
 d8 7Q`DBM ` MU`Tnp`+?QHmBVB M ` MU`Tnp`+?QHmVVfk  
 de 14;TX[mB+FbmKU+2Mvnb+2M`m(mk)»T(mk - mR)  
 dd 7Q`mkBM ` MU`Tnb+2M 7rQ`mRB M ` MU`Tnb+2M`m V V

L FQM2+ Tüb/€K2 9í2HQpQm 7mMF+B- b/ÿHQQ2 KQ/2Hm- ^2 +?  
 ^2K2 KQ/2H bTmbiBiX

d3 Q#D4;TX[mB+FbmKU  
 dN ;`7nb+2M`m(mR - B - D)»t(B - D)  
 3y 7Q`mRBM ` MU`Tnb+2M`m V  
 3R 7Q`BBM ` MU`Tnp`+?QHmV  
 3k 7Q`DBM ` MU`Tnp`+?QHmVVfk  
 3j  
 39 KQ/2HkX b2iP#D2+iBp2UQ#D - :\_"XJALAJAw1V  
 38 KQ/2HkX QTIBKBx2UV

L HBDbK2i2/vQTiBk€HNBQV;Fi2M/QKBMxM D 2Qü+2? 2MB+ FQm  
 /QKBM M+Q T`pMQ?Q bimTMÿX \*2MviQ?QiQ ü2 2MQ T`Q D2/MQi  
 bi2DMÿ D FQ +2MvDü2 Q M Q -e8- 9N-83- 8R-j- jd-8d 9y-8eX PTiB

je

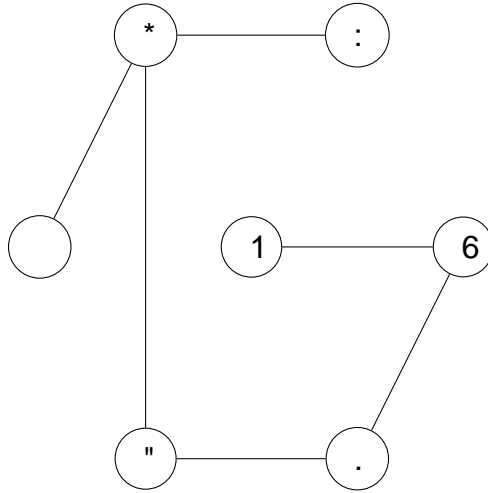

P#`€x2F 9X9, :` 7 QTİBK€HMQ?Q ü2 2MQ p2 bKvbHm biQ+? bi

xQ#` x2MQ p X9 S Q` QpM2DK2 i iQ ü2 2MQ€K2 ix Q#H\*2M ü2 2  
 TQ/H2 b+ûM€üi ?Q/MQiv M / b2#Qm TüQbHm Q bi2DMûKm b+  
 >Q/MQiv b2ü x2Mû TQ/H2 b+ûM€üi b2 M€K H2 KQ+ M2?Q/Q  
 ?Q/MQiv b2ü x2Mû i F- #v+?QK F ^/û +2Mÿ b+ûM€ü2 MQpû?Q  
 +2Mm b+ûM€ü2 TipQ/MQ?Q ü2 2MQ i F- #v +2M MQpû?Q ü2  
 M€K Ki^2 TQbHQm^Bi T2`Kmi ÍMQ K iB+2- F92V8 B2v5 QmN€biQ  
 #QK2 p2FiQ` +2M b+ûM€üi TipQ/MQ?Q ü2 2MQ iQmiQ T2`Kmi Í  
 b2ü x2Mû +2Mv- p X i #mHF

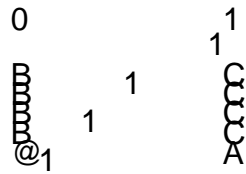

P#`€x2F 9X8, S2`Kmi ÍMQ K iB+2 ü2 2MQX

a + ûM €üR	k	j	9	8
x <sub>0</sub>	93-y8	8j-d9	8y-jj	9k-d jd-33
x <sub>QTi</sub>	9k-e8	9N-83	8R-j	jd-8d 9y-8e

h #mHF 9Xk, SQ`QpM€MQ ü2 2MQX

x <sub>0</sub>	9k-d8	8y-jj	8j-d9	jd-33 93-y8
x <sub>QTi</sub>	9k-e8	9N-83	8R-j	jd-8d 9y-8e

h #mHF 9Xj, SQ`QpM€MQ ü2 2MQX

9X9X L1CE\_ h P \*1ah o :\_ 6l

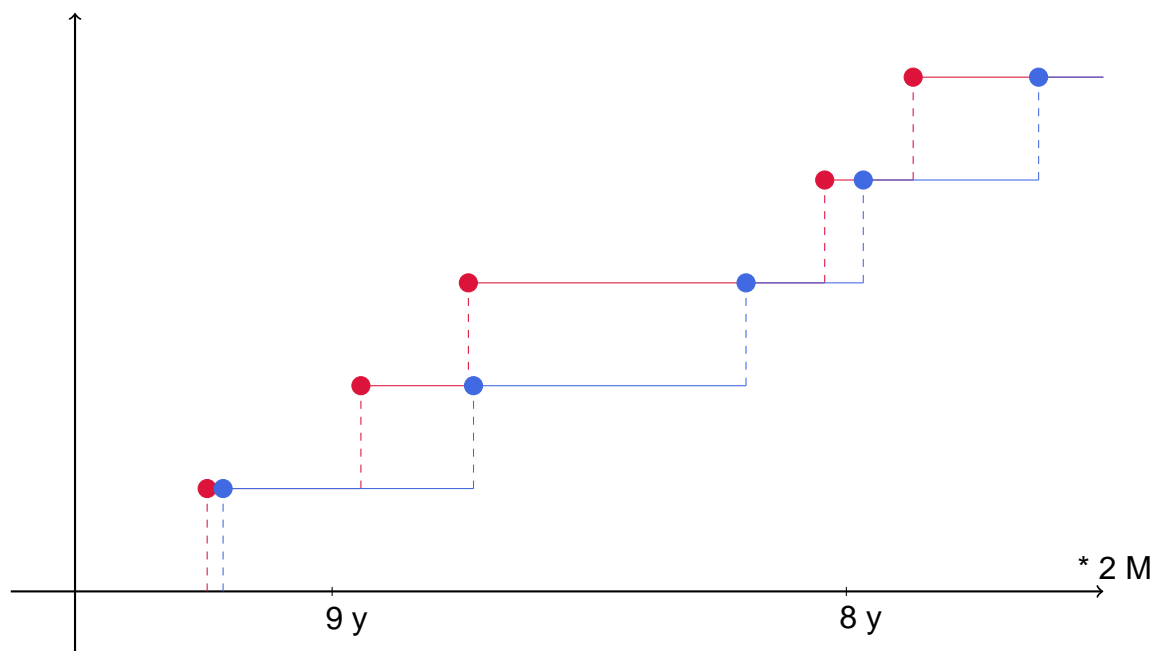

P#`€x2F 9Xe, .Bbi`B#míMQ 7mMF+2 TQ`QpM€p Mw+? i

o i #mH~~9x2~~ p ;` 7~~9x2~~ B /Q#ü2 pB/ÿi- ^2 MQpÿxM, Q2x2pîüQ @MQ  
 KBMmD2 TipQKMDiQ2?2MIB+FQm /QKBM M+Q T`pMQ?Q bimTMÿX o  
 i` bv K2i` i2/v Ki^2K2 pvTb i pw#ÿ`Qpû üQx2MQ M xpQH2MQm i`  
 GQ;B+FwK TQF` ÍQp€MQK p 9HQx2 ?H2/€MQ KBMBK€HMQ FQb  
 K€HMQ FQbi`m ;` 7m b p2HFwK KMQ^bipQK p`+?QHIX o iQK b2 i iQ  
 T`QiQ^2 D2 M€`QíM€ M QT2` ÍMQ T Kÿ#XL TQíQi ÍB b k9 : " \_ J #v  
 M DQi KBMBK€HMQ FQbi`m /QKBMmDQ+Q pw+?QxQ FQbi`m biQ+?  
 m ;` 7m b K tBK€HMÿ ky p`+?QHvX o iQKiQ TüQT /ÿ p F #vH pwTQ  
 #2xK€H e KBMmiUM ÍivüD€/`QpûK T`Q+2bQ`m BMi2H B8@e8yyV  
 p TüQHQx2X

JQ^MwK ü2 2MQK #v KQ?HQ #wi TüB ?H2/€MQ KBMBK€HMQ FQ  
 iB+Fû /QKBM M+2 TQm^Qi pwFQMMÿD Q bi`QDX . H Q KQ^MQbiQ  
 TüQT /Mÿ pvipQüBi ü2 BÍbT2+B HBxQp Mw M i2MiQ ivT 9HQ?X

L /`m?Qm bi` Mm M2MQ T`Q#HûK T` +Qp i b p2HFwK KMQ^bipG  
 TQíim b+ûM€üi b2 iQiB^ M2xpv mD2 TQí2i TQ/KQM2F KQ/2Hm- Fi2  
 KÿiQX

9X9X L2DF` i Q +2bi p ;` 7m

o M€bH2/mDQ+Q 9HQx2 bB mF€^2K2 BKTH2K2Mi +B biQ+? biB+  
 8HQ? - Fi2`Qm b2 #m/2K2 piüiQ TQ/F TBiQH2 x #wp i- #m/2 ?H2/€  
 K2xB /pÿK #Q/vX w /€MQ iüiQ 9HQ?v b2 bFH€/€ x Q?Q/MQ+2Mû?Q  
 Q`B2MiQp Mw- /pQm pv#`t-MFw2#p/2pQ#H?QxQ #Q/- x2 Fi2`û?Q b2 #  
 bM ^Bi/Qbi i/Q +QHxQpKQm#M/m;` 7 D2 xQ#` 9x2TQMí€Q#M€x#Q/  
 D2 p iQKiQ TüQT /ÿ#HQQ pw #QX2 #Q/

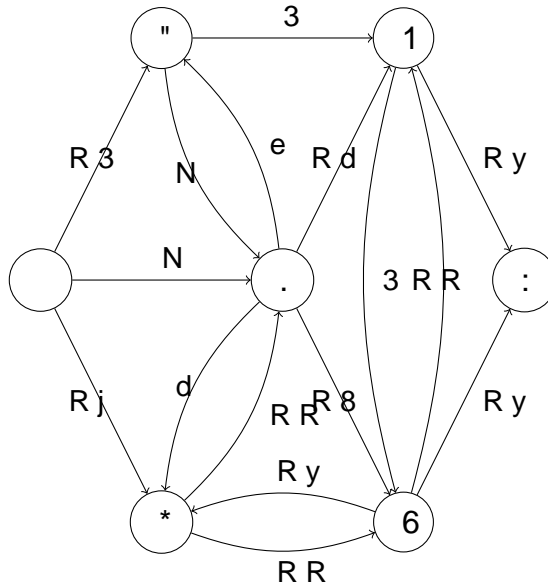

P#`€x2F 9Xd, :` 7 x /€MQ /2i2`KBMBbiB+Fû 9HQ?

h F D FQ p Tü2/+?QxQ 9HQx2 pvm^BD2K2 D FQ pw+?QxQ ü  
 Tü2FQM i- ü2 2MQ /2i2`KBMBbiB+Fû 9HQ?vX ai2DMÿ D FQ p  
 FH bB+Fû H;Q`BiKv M ?H2/€MQ M2DF` i Q +2biv D FQ DbQ  
 /Q QüFv UM TüX .BDFb R p - HHQ`BinkQK2 iQiQ ü2 2MQ M DQi  
 HBM2€`MQ?Q T`Q;` KQp€MQ- #v+?QK i FQpw TQbimT KQ?HE  
 biQ+? biB+FQm /QKBM M+BX

JQbiQ iQ?Q /Qb /QK2 ü2 BÍB M€bH2/mDQ+Q KQ/2H,

$$\begin{aligned}
 & \text{KBM } x_{ij} \quad c_{ij} \\
 & \text{P } x_{ij}^{2V} \quad \text{P} \\
 iX \text{ } ^X \quad & x_{ij} \quad x_{k,i} = 0 \quad 8i \text{ } 2V \text{ nfs;tg} \\
 & j^{2V} \quad k^{2V} \\
 & x_{s,j} \quad x_{k,s} = 1 \\
 & j^{2V} \quad k^{2V} \\
 & x_{t,j} \quad x_{k,t} = 1 \\
 & j^{2V} \quad k^{2V} \\
 & x_{ij} \text{ } 2f0;1g
 \end{aligned}$$

h2MiQ KQ/2H x `mímd2- ^2 x F ^/û?Q #Q/m UF`QKÿ pw+?QxQ  
 iQHBF`€i- FQHBF`€i /Q MÿD pbiQmTQK2X w pw+?QxQ?Q #Q/r  
 FQHBF`€i /Q MÿD pbiQmTQK2- /Q +QHQPû?Q #Q/m pbiQmTQK  
 pvbiQmTQK2X SQFm/ #m/2 9HQ? FQ`2FiMÿ x /€M M2#m/2  
 x€TQ`MQm +2MQm- T F F ^/€ bmK iQ?QiQ KQ/2Hm #m/2 KQi  
 #Q/2K i2/v T`QD/2K2 D2/MQm- M2#Q DQK M2T`QD/2K2 pi#2+X  
 SQ/Qp2DK2 b2 MvMQ M BKTH2K2Mi +B p Tvi?QMmX JQ/mH  
 M BMbi HQp Mû- i F^2 D2 bi ÍQ- bTQHm b Qbi iMQKB KQ/mHv-

R BKTQ`im`Q#BTv b ;T  
 k 7`QK; m`Q#BBTKvTQ`j"

9X9X L1CE\_ h P \*1ah o :\_ 6l

j BKTQ`MmKTv b MT  
9 BKTQ`i M/QK

C FKBH2 K€K2 M BKTQ`iQp Mû KQ/mHv- pvipQüQK2 ;` 7 b2 x  
9HQ?v +2MQpQm Kc\_jB+B b#2`2FK2 TQÍ€i2ÍMQ +QHQPw #Q/X h F  
MmHûK TüQFH /m #m/2 ?Q/MQit M 22F/B/m m Q p Q \*?p??/2K2 T`QKÿM  
BM7/Q Fi2`û /Qb /QK2 M2FQM2ÍMQX

8 BM7 4 :\_"XAL6ALAhU  
e ;` 7 4 MTX `` v U((y - R3 - Rj - N - BM7 - BM7 - BM7  
d (BM7 - y - BM7 - N - 3 - BM7 - BM7) -  
3 (BM7 - BM7 - y - RR - BM7 - RR - BM7) -  
N (BM7 - e - d - y - Rd - R8 - BM7) -  
Ry (BM7 - BM7 - BM7 - BM7 - y - 3 - Ry) -  
RR (BM7 - BM7 - Ry - BM7 - RR - y - Ry) -  
Rk (BM7 - BM7 - BM7 - BM7 - BM7 - BM7 - y)  
Rj p`+? H2W;` 7 V  
R9 b4y  
R8 i4e

.Q T`QKÿM MûK2 x / HB T`pM Q m p H Q Q HT`QiQ^2 Tvi?QM BM/2tm  
SQ/Q#Mÿ TQb B2D M Q2#x/ HB 2biFQmX

LvMQ Ki^2K2 pvipQüBi KQ/2H- BMB+B HBxQpt iTpQMÿK KviB+B T  
UTQxQ` - i2MiQF`€i K€K2 Q`B2MiQp- Miv D`Mÿ-D F Q K i B-72x /€MQ  
M2MQ bvK2i`B+F€V TüB/€K2 QK2x2MQ 9Í2HQpQm 7mMF+B x pv  
M2DF` i Q +2bivX

o +vFHm #m/2K2 T`Q+?€x2i Tü2b p 2+?Mv p`+?QHvX SQFm/ M `s-  
TüB/€K2 TQ/KQMFm- ^2 TQÍ2i pv+?€x2DQ+Q+? ?` M KmbQ #wi Q  
?` MX SQFm/ M ` xQK2tM Tü Q H Q K 2 T#Q K Q M F m - ^2 `Qx/QH pw+?Qx  
xQ+? ?` M KmbQ #wi @RX o Qbi iMQ+? TüQT /2+?- i2/v TQFm/ p`  
+QHQPw- x /€K2 TQ/KQMFm- ^2 `Qx/QH TQÍim ?` M pv+?€x2DQ+Q  
p+?€x2DQ+Q+? /Q iQ?QiQ #m/m D2 MmHQpwX

Re KQ/2HR 4 ;TX JQ/2HU ôw FH /MBnKQ/2H ôV  
Rd t 4 KQ/2HR X //o `bUTnp`+?QHm - Tnp`+?QHm - pivT24:\_"X  
R3  
RN7 Q`B BM ` Mÿ T np`+?QHm V ,  
ky B 7B44b ,  
kR KQ/2HR X //\*QMbi`U  
kk ;TX [mB+FbmK U7(Q`F B MF) Mÿ T np`+?QHm V) V  
kj • ;TX [mB+FbmK U7(Q`F B MF) Mÿ T np`+?QHm V) V  
k9 44 RV  
k8 2 H B 744i ,  
ke KQ/2HR X //\*QMbi`U  
kd ;TX [mB+FbmK U7(Q`F B MF) Mÿ T np`+?QHm V) V  
k3 • ;TX [mB+FbmK U7(Q`F B MF) Mÿ T np`+?QHm V) V  
kN 44 •RV  
jy 2 H b 2

jR KQ/2HR X // \* Q M bi` U  
jk ;T X [m B + F b m K U 7 ( Q ( F B B - M F ) ` M U J T n p ` + ? Q H m V ) V  
jj • ;T X [m B + F b m K U 7 ( Q ( F B B ) ` M U J T n p ` + ? Q H m V ) V  
j9 44 y V  
j8  
je Q # D 4 ;T X [m B + F b m K U ; ` 7 7 Q ` D B M » f ( M U J T n p ` + ? Q H m V  
jd 7 Q ` B B M ` M U J T n p ` + ? Q H m V V  
j3  
jN KQ/2HR X b 2 i P # D 2 + i B p 2 U Q # D - : \_ " X J A L A J A w 1 V  
9y KQ/2HR X Q T i B K B x 2 U V  
9R  
9k ` 2 b m H i 4 M T X ` 2 b ? T 2 U K Q / 2 H R X ; 2 i i i ` U ö t ö V - U • R -

SQ b T m i y M Q D b K 2 M H 2 x 2 H B Q Q / B I Q € M Q í 2 H Q M Q 7 m M F + 2 j j X  
x Q # ` x 2 M û M Q # 3 M € K m # m / 2 b H Q m ^ B i D F Q # 2 M + ? K ` F F M H 2  
T Q K Q + Q b i Q + ? b i B + F û / Q K B M M + 2 X

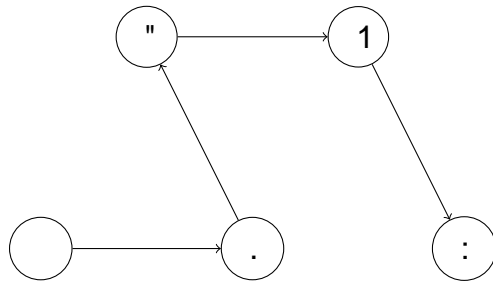

P # ` € x 2 F 9 X 3 , û 2 2 M Q / 2 i 2 ` K B M B b i B + F û 9 H Q ? v M 2 D

E p w T Q í m T Q K Q + Q b i Q + ? b i B + F û / Q K B M M + 2 T Q i ü 2 # m D 2 h  
m ^ B i w K Q / 2 H T ` + m D 2 b M m i M Q m - H 2 M 2 T Q b i í m D Q + Q T Q / K Q  
; 2 M 2 ` Q p , i m / y H 2 € K 2 K H w T Q Q m Q B D 2 K 2 b + û M € ü x 2 x / € M Q / 2 i 2 ` K  
F M y K m T ü B / € K 2 T 2 í H B p y x p Q H 2 M w b + x M / € ü K B M m D Q / 2 Q M Q 2 H  
b i Q + ? b i B + F Q m / Q K B M M + Q / ` m ? û ? Q b i m T M y X S Q F m / # v + ? Q K i  
p 2 H K B í b i Q # v b 2 b i € p H Q - ^ 2 ü 2 2 M Q M H 2 x 2 M û i Q K i Q K Q / 2 H  
b i Q + ? b i B + F Q m / Q K B M M + Q / ` m ? û ? Q b i m T M y X

9j T n b + 2 M ` m 4 k  
99 ; ` 7 n b + 2 M ` m 4 M T X x 2 ` Q b U U T n b + 2 M ` m - T n p ` + ? Q H r  
98 ; ` 7 n b + 2 M ` m ( y ) 4 ; ` 7  
9e ; ` 7 n b + 2 M ` m ( R ) 4 M T X ` ` v U  
9d (( y - R 3 - R y - N - B M 7 - B M 7 - E  
93 ( B M 7 - y - B M 7 - N - R y - B M 7 - E  
9N ( B M 7 - B M 7 - y - R y - B M 7 - R R -



9X9X L1CE\_ h P \*1ah o :\_ 6l

8y ( B M 7 - e - d - y - R d - R 8 - B M 7 ) -  
8R ( B M 7 - B M 7 - B M 7 - B M 7 - y - 3 - R y  
8k ( B M 7 - B M 7 - R y - B M 7 - R R - y - R y )  
8j ( B M 7 - B M 7 - B M 7 - B M 7 - B M 7 - B M 7 -  
89

88 + 2 M v n b + 2 M H B n b i 4  
8e 7 Q `b + 2 M B `M ` M U 2 n b + 2 M ` m V ,  
8d + 2 M 4 y  
83 7 Q `B B M ` M U 2 2 W ` 2 b m H i V V ,  
8N 7 Q `D B M ` M U 2 2 W ` 2 b m H i V V ,  
ey + 2 M Y 4 ; ` 7 n b + 2 M ` m ( b + 2 M ` ) ( B ) ( D ) » ` 2 b m H i ( B  
eR + 2 M v n b + 2 M ` m X T T 2 M / U + 2 M V

\* 2 M v ü 2 x 0 2 / 2 Q ` K B M B b i B + F û 9 H Q ? v M € K T ü B i y + ? i Q b + û M € ü Q + ?  
L v M Q p v i p Q ü K 2 K Q / 2 H - F i 2 ` w # m / 2 ü 2 B i 9 H Q ? m T Q K Q + Q b i Q + ?  
b i m T M y X w Í M 2 K 2 i Q K - ^ 2 p v i p Q ü Q K 2 K Q / 2 H p M y K D 2 ? Q T ` Q K y M

ek K Q / 2 H k 4 ; T X J Q / 2 H U ô J Q / 2 H n b i Q + ? b i B + F 2 n / Q K B M M + 2 ô  
ej t 4 K Q / 2 H k X // o ` b U T n p ` + ? Q H m - T n p ` + ? Q H m - p i v T 2 4 : \_ " X '  
e9 r 4 K Q / 2 H k X // o ` b U T n b + 2 M ` m - T n b + 2 M ` m - p i v T 2 4 : \_ " X '  
e8 H # 4 y - m # 4 R V

S Q i Q K x / € K 2 T Q / K Q M F v - # v M H 2 x 2 M Q x 2 2 M Q # v H + 2 b i x

ee 7 Q `B B M ` M U 2 n p ` + ? Q H m V ,  
ed B 7 B 4 4 b ,  
e3 K Q / 2 H k X // \* Q M b i ` U  
eN ; T X [ m B + F b m K U ( Q t r ( B M F ` ) M U 2 n p ` + ? Q H m V ) V  
dy • ; T X [ m B + F b m K U ( Q ` F F B - M B ) M U 2 n p ` + ? Q H m V ) V  
dR 4 4 R V  
dk 2 H B B 7 4 4 i ,  
dj K Q / 2 H k X // \* Q M b i ` U  
d9 ; T X [ m B + F b m K U ( Q t r ( B B M F ) M U 2 n p ` + ? Q H m V ) V  
d8 • ; T X [ m B + F b m K U ( Q ` F F B - M B ) M U 2 n p ` + ? Q H m V ) V  
de 4 4 • R V  
dd 2 H b 2  
d3 K Q / 2 H k X // \* Q M b i ` U  
dN ; T X [ m B + F b m K U ( Q t r ( B M F ` ) M U 2 n p ` + ? Q H m V ) V  
3y • ; T X [ m B + F b m K U ( Q ` F F B - M B ) M U 2 n p ` + ? Q H m V ) V  
3R 4 4 y V

. € H 2 T ü B / € K 2 T Q / K Q M F v T ` Q b i Q + ? b i B + F Q m / Q K B M M + B / ` m ?  
T Q K Q + Q x D 2 / M Q / m 2 M û ? Q E m Q b K M 2 M Q p K Q / 2 H m x K Q M y M û ? Q  
T Q T b M û ? Q M Q ^ 2 X S Q x Q ` - T ` Q i Q ^ 2 # m / 2 K 2 ? H 2 / i ü 2 2 M Q / Q K B M  
i B + F Q m / Q K B M M + Q / ` m ? û ? Q b i m T M y - M 2 F Q F i 2 B Q 2 n K 2 b T K 2 2 K Q m í B Q  
T ü B p w T Q í m b i Q + ? b i B + F û / Q K B M M + 2 W T ` F M Q E Q # b b m ? T m D y 2 ? Q 2 M Q E  
x B M i 2 h 0 1 H m b Q m í 2 i M F ^ / û K ü € / F m B p F ^ / û K b H Q m T + B D 2 ` Q p 2 M

$J_i, dXR, ; B, Kp, Ga, ; O \quad XaO-; O$

$$\begin{aligned}
 & \setminus S^P \quad X_{ij} \quad C_{ij} \\
 & P \quad ij2V \quad P \\
 \text{zi } i & \quad X_{ij} \quad X_{k,i} = 0 \quad \delta i 2 V \text{ n fs; tg} \\
 & j^2V \quad k^2V \\
 & \quad X_{s;j} \quad X_{k;s} = 1 \\
 & j^2V \quad k^2V \\
 & \quad X_{t;j} \quad X_{k;t} = 1 \\
 & j^2V \quad k^2V \\
 & X_{ij} \in [0;1] \\
 & P \quad P \\
 & \quad C_{u;i} X_i \quad g P_{;u} \quad \delta u 2 U \\
 & i^2V \quad 2U \\
 & \quad W_{ij} = 1 \quad \delta i 2 V \\
 & j^2V \\
 & \quad W_{ij} = 1 \quad \delta j 2 V \\
 & i^2V \\
 & \quad W_{ij} \in [0;1]
 \end{aligned}$$

3

B

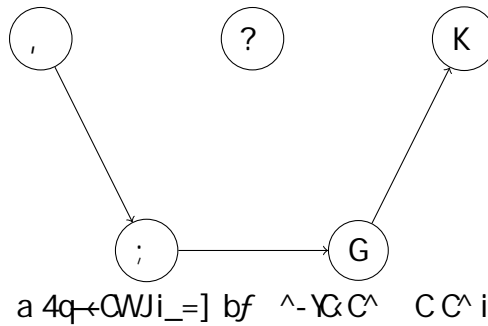

D| \ b@CY| i - @@, b^szqsf  
 D{ Leil ~S<W\$~\ f...9S> U: Hbq S S^ q ^LCfe€s<C^ - q-ggE E c  
 D| Hbq U S^ q ^LCfe€s<C^ - q-gg  
 D| \ b@CY| i - @@, b^szqsf  
 Dv Leil ~S<W\$~\ f...9S> U: Hbq U S^ q ^LCfe€s<C^ - q-ggE E c  
 Du Hbq S S^ q ^LCfe€s<C^ - q-gg  
 DD  
 D\_ \ b@CY| i - @@, b^szqsf  
 \_CE Leil ~S<W\$~\ f  
 \_c Lq H€s<C^ - q- 9-c > S > U: Ö† 9S > U: Hbq U S^ q ^LCfe€fq<PbY-g  
 \_| Hbq S S^ q ^LCfe€fq<PbY-gg  
 \_{ ZE Leil ~S<W\$~\ f <C^%6s<C^ - q- 9-| : Ö..9-| > ~c:  
 \_J Hbq ~| S^ q ^LCfe€s<C^ - q-gg Hbq ~c S^ q ^LCfe€s<C^ - q-gg  
 \_J

Ji Ji ] BTVp, y ; Bry, , Kp, G}

\_v b4UELeil ~S\W~\ fLq-HE s<C^ - q- 9-c > S > U: Ö† 9S>U:

\_u Hbq ~c S^ q- ^LCfe€s<C^ - q-g

\_D Hbq S S^ q- ^LCfe€fq<PbY- g

— Hbq U S^ q- ^LCfe€fq<PbY- gg

d S@ \ C cObfb~ H^WS<fb\ C \ S\ S\ -YS-ç^ YbP~ - \ C \ C \ b@CYse~szSi

cCE \ b@CY i sCza 4UC<zSfCfb4U> Kp3i [ R R R Bg

cCE \ b@CY i bezS\ S Cfg

0;5 0;5

0;5 0;5

a 4q<CWJicCE [ -zSC Wi

r < ^—	c	
x <sub>0</sub>	{ {	{ l
x <sub>bez</sub>	{ J	{ c

y-4~YW JiJ=dbqf^~^ C C^ i

] - YS\ C ^bf C C^ x<sub>bez</sub>>fS Lq-HJi\_i, S@ \ C > C ^-Y&C^ C C^ x<sub>bez</sub> UC ^-edpszb  
 b@S^ b@e fb@^ Pb C C^ x<sub>0</sub>; C^%d^bf Pb C C^ e S^~Pb@^ <P s< ^~ <P ^~ f%o%o  
 {c - {Ji ? ~C\ Ceb\ b< \ b@CY- ^- Y\ -zSSW\ 4S^< W>fS JicCE

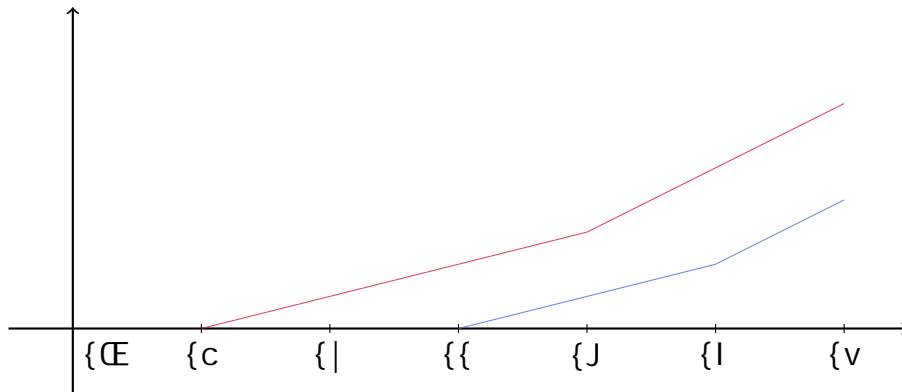

a 4q<CWJicc=R^zLq-YUVb H^WC Pba^ \ G C < @SzqS1-ç^ <P H^W i

dbqf^d\ C b4 C C^ i; C^%b4b~ C C^ e Sb4b~ s< ^~ <P lsb~ <-es^%f z-4-YC  
 Ji Ji , Lq-H Jicc lsb~ <b4q<C^%S^zLq-Y%UVb H^WC Pba^ \ G C b4b~ C C^ i [ C C  
 sC f ^ \ e Gsf @cS> C ^bf C C^ x<sub>opt</sub> fCqfC^ g beq f@~ @b\ S^~UC e fb@^ C C^ x<sub>0</sub>  
 f\ b@Gg szb<P-szS\~ @b\ S^~^< @q-P Pb sz~e^ >edpzb C Pb@^bz- UC Pb S^zLq-Y- UVb  
 H^WC Pba^ \ G C UC b@Pb@^bz%fc bsz C f z i

db@fC\ CsCz-W ^- Lq-H@SzqS1-ç^ <P H^W e fb@^ Pb C C^ x<sub>0</sub> - ^bf ^-Y&C^ Pb  
 C C^ x<sub>opt</sub> fLq-HJic|g TCfS@ z> C CqfC^ ~@SzqS1-ç^ H^WC C C^ x<sub>opt</sub> UC f @%f z ^C4b  
 qf^~ \ b@q @SzqS1-ç^ H^WSe fb@^ Pb C C^ x<sub>0</sub> - ^- ^ W C q <P S^zCqf-YC-P UC @Vb^<C

bsz C f z i C C^ ^-Y C^ eb\ b< zbPzbz \ b@CY- zC@%@b\ S^-UC C C^ f <Pbx @CzCq  
 \ S^SzS W YbP% ^CUC^ szb<P- szS W @b\ S^- ^< @q-P Pb sz-e^ >-YCz-W szb<P- szS W  
 @b\ S^- ^< eqf^ Pb sz-e^ i

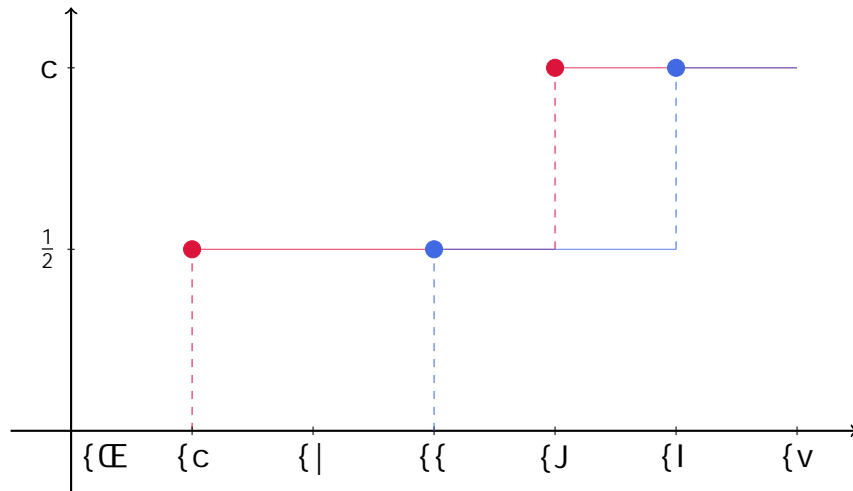

$$a 4q \leftarrow CWJic \mid = ? SzqS4-c^H^WkD$$

T-Ws\ C-W<-Y^ z <Pzb @fb~ e W @C<P>szb<P- szS W @b\ S^- ^<SUC f% z ^CUC^  
 ^- bezS -Y- S" ^- ^c^ <P S'fCzS^ C4b f c- sbf bezS -Y- S- YCz-W ^- YS4bfbYb~ YbP-  
 C SzC^b~ eb\ b< Y^G-e^ Pb eqLq \ bf^ i rzb<P- szS W @b\ S^- ^<C \ C \ z f% Sz  
 f s bf <P YbP-<P>W Cq sC c- szb f% W U f S^ C^ qSW <P -eY W < <Pi  
 } W<- YS\ C sSz- W > CUCUC @^b@- C f% fb S \ b@CYeq C S L-qb4Sf eqLq \ bf-Q  
 <\ U<%Ce% Pb^i , YCq^- zSfb~ WU<%A e% Pb^ \ C 4 z sbH...qK, [ r>W Cq f-4  
 <-eS\ e S f% f-C^ \ b@CY >- W Cq ~\ sebY-eq <bf-z s fC W \ \ ^b szf \ C S >  
 f cZ^ L-qb4S , ^CebS\ C@^ -@ S\ C sSz- W -W<-Y C U W S C \ -> C f% fb C^ \ bQ  
 @CY^ C C^ szb<P- szS W @b\ S^- ^< @bW-C C U W 4G fC W ^> -P% eY W f-z ^- fC W  
 \ ^b szf YbPi

# l i Š-f q

, z zb @e\ b\ bf eq <S^-f-<-U< ^- 4-WY-sVb- eq <S9||:>4%% @C' ^bf-^ - szb-P-sQ zS-W @b\ S'-^<Ceqf^ Pb>@q-P Pb - z Cz Pb sz-e^ - 4%% czC^—Sebes-^ - f%sf zC^ - ^- U@^b@-P <P f<bqpf <P e VV @C-Pi ? -C 4%%sz-@bf-^%s-VV @^ - ebVpçSY fY-sz^bszS zbPzb -e-q-z- \ -zC\ -zS-W bezS\ -Ys - <D

, @Y <P WeSbY <P 4%%W<-^%d b ^ -eYV<C szb<P-szS-W @b\ S'-^<C f ç-sbf bezS\ -Ys -<Sf @beqf - z%zb \ Cz@%4%%ebqf^<-^%s US^ \ S\ Cz@ \ Seb- f-^ \ S f z zb eq4Y\ -zS<D

? -C 4%%ebes-^%o^ VVq @CzC\ S'SzS-W Lq-Hbf YbP%f\ S'S -Y^ Vbszq Lq-H - ^UVz <Csz- f Lq-Hg - 4%b -W<-^b>UW\ <e sb4C\ sC @U \ b@S Vbf-z ^- YbP%o seqfV\ ^-Pb@%o- UWz%zb YbP%oC C Sz eb\ b< YS'G-e^ Pb eqLq \ bf-^ i V PY@^ \ S'S -Y^ Vbszq%bq-H eb\ b< szb<P-szS-W @b\ S'-^<Ceqf^ Pb sz-e^ 4%%sCsz-fC^ \ b@CY f eqLq \ bf-< \ U<%C e%zPb^ eq <-U< s C Sç\ L-dp4S yC^zb \ b@CY <Cbç sCY^ Pb YS'G-e^ Pb eqLq \ bf-^ 4%%@-C -eqfC^>-4%PY@Y ^UVz <Csz- f Lq-H s eb\ b< szb<P-szS-W @b\ S'-^<C@q-P Pb sz-e^ i a 4- z%zb \ b@C%4%%çfç-4^ ebes-^%o 4%çC Cç^z-Y^ @Y%eb- z f @Y <P eq < <Pi

# X S C q z ~ q

9: XB, ^ >O-S i rzb<P-szS< @b\ S'-^<C=R'fCz\ C'z @C-Ss^ \ -V\$'L ~^@Cq ~^<Cqz-S'S%o  
| ^@C@Ss^i req\$'LQq| CEEi R 3] \_uDCE DuQ\_{ CE D

9: ? } d, æa, - >TtVad, >[ i pb4-sz^CsbHbezS -YebqzHbYs ~^@CqfSW- ^@szb<P-szS<  
@b\ S'-^<C <b^szq S'zsi B-dpeG ^ Tb-q'-YbHa eCq-zb^-YpCsC-qP 9^YS'Ci B YScfSQ  
3i, >| CEJ>| {Jf| gJ{JQJc 9Si | CECEQ{:i ? a R=cCEcCEwWlUbj| CE{iCEiCEi R r }  
CEuuQ| cui

9: V, XX>dCzCq-^@rzCS^ „ i „ , XX, ; Bi rzb<P-szS< ddpLq\ \ S'Li ] C.. ^ bqW#TbP^  
„ SC%o rb^s>c\_{i R 3] \_uDCEuc\_| cl D|i

9: „ , XX, ; B>ri „ i -^@VR K>, i [ b@CS'L ..SP rzb<P-szS< ddpLq\ \ S'Li req\$'LQq  
, Cq'L>| CE|i R 3] \_uDCE DuDuDcvQi

9: p} rS; S^ ] rVR, ^@q CUCz -Y O-^@4bbW\$ S' a eCq-zb^s p CsC-qP -^@[ -^<L\ C'z  
r<S^<C>fbY cCEr zb<P-szS< ddpLq\ \ S'Li , \ szCq@ \ =B YScfSQj eei cQD|i | CEi R 3]  
\_uDCEJJQCEi JQvi

9: rpBaa ] ; ORy, >rb^Ls-W„ S'LO/C-^L„ a] K>rb\ eb^L? Oa[ da] Kr, - O-^L  
yi ] K} ^ B] i rzb<P-szS< ? b\ S'-^<C-^@, eeYs-zb^s zb GS'-^<C>p SW-^@B<b^bO  
\ Ss 9^YS'Ci ; P-e\ -^ -^@O-YWp; >| CE 9Si | CE| CEQ{:i R 3] \_uDcJ| CE| vuD  
? bsz-e^ <=@bSeCEc| CEw\_uDcJ| CE| vuD

9: [ ] VOBpTBB>ri di - , i ; O, yy BpTBBi rzb<P-szS< @b\ S'-^<CbHPSLPCq bq@Cq -^@  
Ss S eYs-zb^si ; b\ \ ~^S-zb^s S' rz-zSzSs Oy PCbq%o ^@[ CzPb@si c\_| >| cfug  
c\_uu@\_Dvi R r } CEvcCE| vi ? bsz-e^ <=@bSeCEcCEwWlUbj| CEiCEiCEi

9: G, ] K>^ S- y PScp%da ryi OS L P C Q C C z b<P-szS< @b\ S'-^<C bezS -Y\$%o ^@C O  
<S^<%B-dpeG ^ Tb-q'-YbHa eCq-zb^-YpCsC-qP 9^YS'Ci | CEu>| vcf{g\_DJQ\_{ 9Si  
| CE| CEQ{:i R r } CEuu| cui ? bsz-e^ <=@bSeCEcCEwWlUbj| CEiCEiCEi

9: „ } >† S'L - ^ ~ f[ -q<bg ] RBi [ b@CS'L OCzCpL^Cb-s p SWY-V\$'L 3CP-f\$Q S'  
pb-zC; PbSG=, rzb<P-szS< ? b\ S'-^<C, eep<-Pi ddp<C@S Qrb<SY-^@ 3CP-f\$Q  
q-Yr<S^<C>S 9^YS'Ci | CEc>cu>{D| QCE 9Si | CE| CEQ{:i R r } cDuuCE| Di ? bsz-e^ <=  
@bSeCEcCEwWlUbj| CEiCEiCEi | {

9: CE ] RB>^ ~>† S'L „ } - y Szb Oa[ B[ Q BQ BXXai a ezS -Yd-zP ddp4Y\ s ..SP  
rCb^@C q@Cq rzb<P-szS< ? b\ S'-^<C ; b^szq S'zsi ] Cz.bqW# -^@ re-zSY B<b^bO  
\ Ss 9^YS'Ci | CE| >c| fJg| vcQ Du 9Si | CE| CEQ{:i R r } clwC@{ti ? bsz-e^ <=  
@bSeCEcCEwWlUbj| CEiCEiCEi

9c: ?, ] V>GSSei VbYb^- zpbYU-s <- <-sz-fVb~ @YcQW4 PC\ zfb < sC^> q<%o-  
zpbYUbf \ fC@C^ @^Cci c|i | CEi R^=3q^ ^sW-[ O? 9^YS'Ci ? bsz-e^ <=Pzes=vwQ  
Hbzi4\ P@<wHbzbvcl | cJ|

9: V} ar[ , ] B] >y S bi B' <S^z ? S'CsS <-zb^, <bq@S'L zb rzb<P-szS< ? b\ S'-^<C  
; qzCqSi [ , ] , KB[ B] y r; RB] ; Bi | CE>| CEcQ>c{ \_cQ{ \_vi ? a R=cCEc| Dui R r }  
CEi | CEi

XRYBp, y} p,

Q{: Op, 3B; >?itdadBX, >dit] a, ay] >TitO, } KB] >VitaXry, ?>, i yPCrzbO  
<P-sz< ] Cz.bqW? Csl^ dcp4Y\ ..SP dq\$S'Li R^ cDzP R^zCq^-zSb^-Y; b^HqC^<C bH  
rbH; b\ e~zS'L>[ B] ? BX |CE| fSc\_|llg [ C^@CYTb-q^-YsCqSi |CE|i 3q^b=, } y >  
|CE|i ei JcvQ|ci R 3] =\_uDCEQcJQlJCEvi Rr] =cDCEQDcJi

QJ: ] , rO>rzCePC^ -^@ra GBp>, qCYi XS'G-q-^@^b^YS'G-qeqLq\ \ S'Li [ <Kq..Q  
QSY>c\_|i R 3] \_uDCEQDucQvcCE

Ql: 3, Š, p, , >[ bVPz-qriT, p, R>TbP^ Ti -^@rOBp, XR>O-^SH?i XS'G-qeqLq-Q  
\ \ S'L -^@^Cz.bqW•b.si JzP C@ Ob4bVQ^>] iTi=TbP^ ,, SC%o rb^s>|CECE R 3]  
\_uDCEQucQv|u|CE

Qv: ] B By RX>Ti yCbqC Lq-H q C Cz S'>c\_u\_i ci f%ai dqP-=r] yX Q] -WV@zCszf  
zC^P^S^W YS'qz-q%oc\_u\_i {cv si

Qu: G] ; Or>Bi dq<C< @ US^ f @%o, bY |c> sz-f eqp sb-@b4 @ US%o, æp>dqP->  
|CE>R 3] DCE|DI CECE>v\_DCE

QD: 3a p , V, >aia USz \ eqp4Y\ ~\ S'S \ Y^ \ f; <C>Pg dq<C[ bq-fsW e cp@bf Q  
@C^W sebYc^bszS>sfj RRR>seS {>c\_|v>{uQD

Q\_: K ~cp4S aezS S-zSb^> Xi= K ~cp4S aezS S'q pCqC^<C [ -^--Y f|CE|g  
Pzze=vw.....iL~cp4S<b\

QE Ob...zb LCz -Ys-4sCzs bH- sCzmfeb..CqCzj R^=rz-<Wb..Cq b... Q^YS'Ci ? bsz-e^ <=  
Pzses=vwz-<WbfCq b..i<b\ wvwJD|{cv

Qc: 3RpKB>TbP^ pi - Gq^ebS Xa } , B, } ti R^zcp@-zSb^ zb szb<P-szS eqpLq\ \ S'Li  
|^@C@ ] C...^ bqW^reqS'LCq><|CEci rCqS S' beCqzS^s qCSC-qP -^@"^^-^S YC^LSQ  
^CqS'L freqS'LCqj R 3] \_uDCEQvcJCE{vQii

Q|: 3pŠa 3a O, y >T-^i [ -z\ -zS^W \ b@C%@beqf^ <P YbPi 3q^b>|CECE? bsz-e^  
z-W <= Pzses=vw.....if~z4q<vwz-@C^zSw-f@q <Qv@Cz-S'vc||{ \_ui 3-WY-sW-eq<D  
, %bW ~c^ zC^P^S^W f 3q^ >G-WVz- szpU^ Pb S^ C^ qzf > sz-f \ -z\ -zS^W%o, Q  
@b~< eq<Cd-fCYdbeCYi

# vi rCα ^- \ e YbP

rb-ç-sz z zbeq<CUCz-W W@ CC^ ^-es-^ f U<%Ce%Pb^i, e Sb C^ \ -q<PŠ~  
eqSYbP% Se Lsb~ sb-4bcf%o

\S^S\ -Y^S€Mszq-€Lq-Hi e%o

^CUMz-sS€<Csz-€f€Lq-Hi e%o

fCVM€-YbP-i e%o