

Least Perturbation Based Method of Multi-Objective Null Placement in Linear Antenna Array using Evolutionary Algorithms

Soumyo CHATTERJEE¹, Baisakhi BANDYOPADHYAY², Sayan CHATTERJEE², Arijit MAJUMDAR³

¹Dept. of ECE, Heritage Institute of Technology, Kolkata-700107, India

²Dept. of ETCE, Jadavpur University, Kolkata-700032, India

³SAMEER Kolkata Centre, DeitY, MCIT, Govt. of India, Kolkata-700091

soumyo.chatterjee@heritageit.edu, sayan1234@gmail.com

Submitted November 22, 2021 / Accepted June 13, 2022 / Online first August 16, 2022

Abstract. *The paper proposes a novel least perturbation based method of constrained null placement for a non-uniformly excited linear antenna array. Synthesis of amplitude and phase of edge element using least perturbation based analytical technique for required null placement leads to degradation of pattern in terms of increased side lobe level and beam broadening. Further computation capability of the method of least perturbation has been enhanced using an evolutionary algorithm. Subsequently, suitable evolutionary algorithms have been employed to find the optimum value of excitation and phase of edge elements subject to constraints of side lobe level reduction, beamwidth narrowing, and main beam control. Design of 8 and 15 elements linear array with a 95% reduction in computation time elucidates the capabilities of the proposed method. Further 3D electromagnetic solver-based validation process has been used to ascertain the practical acceptability of the method.*

Keywords

Null placement, beam steered linear array, minimum perturbation, excitation distribution, evolutionary algorithms

1. Introduction

In modern day communication systems, the ability to eliminate unwanted interference sources in complex electromagnetic environments is most desirable. Traditionally, suppression of signal originating from unwanted sources is carried out by masking the interference signal in a particular direction. Accordingly, null positioning methods in antenna array systems are based on an analytical approach [1–5], [7], [10], [15], [18] and by using evolutionary algorithms [6], [8], [9], [11–14], [16], [17], [19–28] have been implemented by researchers, for achieving single, multiple and wide null placement in beam steered linear array. In those approaches, phase [6], [8] [9], [12], element spacing

[7], [13], [14], [24], [27] and real valued excitation [10], [15], [16], [18–20], [28] have been controlled individually or in combination [11], [17], [21–23], [25–26] for realizing the null placement. In [1], Schelkunoff proposed an analytical method for obtaining excitation amplitude distribution subject to null placements [1]. Since then, Hans Steyskal et al. [2] and H. M. Ibrahim [3] have employed different methods of adaptive null placement through excitation amplitude calculation. Among them, the method of independent null steering by using weight can be anticipated to be the most efficient as each null position is associated with independent weight [3]. Consequently, if the direction of interference changes, then only the element associated with that new null position can be controlled for obtaining desired null placement [10]. However, when the number of interference sources is too small compared to array size, the method is less sensitive to element positions. This limitation has been overcome by perturbing the position of selected elements, subject to minimization of power at null locations and power fluctuation in the main beam [7]. In [18], Jafar et al. have reported a method in which additional amplitude and phase of two edge elements have been controlled analytically using a model involving a uniformly excited linear array subject to desired null placement. However, it has been observed that such a mathematical model needs an initial assumption of edge elements' excitation for null placement. Consequently, the acceptable value of the excitation amplitude and phase of edge elements depends on assumption of initial value leading to the unwanted null placement and enhanced computation time.

Although all the analytical methods are quite efficient in realizing adaptive null placement, all of them have some inherent limitations in the form of complex hardware, computation time and lack of robustness against the multiple conflicting objectives. To overcome these limitations, various evolutionary algorithms like Genetic Algorithm (GA) [6], [17], [24], [27], Particle Swarm Optimization (PSO) [8], [12], [19], [22] and its variant [14], [26], Sequential Quadratic Programming (SQP) [9], Pattern Search (PS) optimization [11], Differential Evolution (DE) [13],

Taguchi Method [16], Spider Monkey optimization [20], Flower Pollination Algorithm [21], [23], Cross Entropy Based Optimization [24], Strawberry Optimization Algorithm [25] and Mayfly Algorithm [28] have been used for null placement. All these algorithms control the excitation amplitude, inter-element spacing, phase individually or in combination of aforementioned parameters for achieving null placement under multi objective scenario. For example, in [28], Mayfly Algorithm has been used to obtain null steering with side lobe level (SLL) constraint by optimizing the excitation amplitude of the linear antenna array. Further same synthesis objectives have been revisited by varying positions of the array elements. Both experiments show partial effectiveness of the method as it suffers from increased beamwidth. Further low side lobe level pattern synthesis of uniform linear array has been discussed using BAT algorithm and statistical mean method in the presence of array errors [29]. Then a novel pattern synthesis algorithm for antenna array has been discussed in [30] for eliminating ranges ambiguity in LT-1 mission via sequential convex optimizations. However, it must be noted that success of the aforementioned evolutionary algorithm-based methods come at the expense of selective or complete perturbation in excitation distribution and inter element spacing. Subsequently, change in null position leads to recalculation and repositioning of array elements which needs additional support mechanism in terms of enhanced system complexity. Consequently, it is desirable to develop a constrained null placement method that requires least perturbation in excitation distribution with no change in existing inter element spacing.

The article in discussion proposes a method of null placement in non-uniformly excited beam steered linear array wherein only excitation amplitude and phase of edge elements has to be perturbed subject to null placement leading to minimum perturbation with respect to existing complex excitation distribution of the linear antenna array. Further, when combined with an evolutionary algorithm, the method can place desired null without adversely affecting other radiation parameters which in turn shows constrained null placement capabilities of the proposed method. Present investigation considers particle swarm optimization (PSO) and differential evolution (DE) separately as representative evolutionary algorithms to illustrate the capability of the method in a constrained scenario. The method uniquely considers variation in excitation and phase of only edge elements which leads to considerable reduction in computation time. Moreover, the method can be developed using any optimization algorithm wherein constraint null placement in linear array with different excitation distributions can also be achieved.

2. Proposed Method

Array factor of beam steered linear array ($AF(\theta)$) can be expressed as the sum of array factor due to edge elements ($AF_E(\theta)$) and array factor due to rest of the elements ($AF_R(\theta)$). For even numbered array ($2N$) subsequent ex-

pressions have been represented in (1) to (4):

$$AF(\theta) = 2 \sum_{n=1}^N a_n \cos \left[\left(\frac{2n-1}{2} \right) \psi \right]. \quad (1)$$

In (1), $\psi = kd \sin\theta + \beta$ wherein $k = 2\pi/\lambda$ represents wave number, d is the uniform inter-element spacing, $\beta = -kd \sin\theta_s$ expresses progressive phase difference between two consecutive array elements with θ_s being the main beam position and θ is the elevation angle with respect to array axis. Moreover, a_n is the excitation amplitude of the n^{th} element of the array and a_N represents the excitation amplitude of edge element of the array.

$$AF(\theta) = 2 \sum_{n=1}^{N-1} a_n \cos \left[\left(\frac{2n-1}{2} \right) \psi \right] + 2a_N \cos \left[\left(\frac{2N-1}{2} \right) \psi \right], \quad (2)$$

$$AF_R(\theta) = 2 \sum_{n=1}^{N-1} a_n \cos \left[\left(\frac{2n-1}{2} \right) \psi \right], \quad (3)$$

$$AF_E(\theta) = 2a_N \cos \left[\left(\frac{2N-1}{2} \right) \psi \right]. \quad (4)$$

In (5) array factor expression has been modified to express in exponential form. Such modification has been carried out to illustrate the contribution of the edge elements in the overall array factor expression.

$$AF_E(\theta) = a_N e^{-j \left(\frac{2N-1}{2} \right) \psi} + a_N e^{+j \left(\frac{2N-1}{2} \right) \psi}. \quad (5)$$

Similarly, for odd numbered linear array ($2N+1$) relevant array factor expressions have been as represented in (6) to (9):

$$AF(\theta) = 2 \sum_{n=1}^{N+1} a_n \cos[(n-1)\psi], \quad (6)$$

$$AF(\theta) = 2 \sum_{n=1}^N a_n \cos[(n-1)\psi] + 2a_{N+1} \cos(N\psi), \quad (7)$$

$$AF_R(\theta) = 2 \sum_{n=1}^N a_n \cos[(n-1)\psi], \quad (8)$$

$$AF_E(\theta) = 2a_{N+1} \cos(N\psi). \quad (9)$$

The array factor expression of (9) has been written in the exponential form given by (10) to illustrate the contribution of edge elements

$$AF_E(\theta) = a_{N+1} e^{-jN\psi} + a_{N+1} e^{+jN\psi}. \quad (10)$$

From the analysis of array factor expressions, it has been observed that the perturbation in edge element excitation has the potential to achieve pattern synthesis. Consequently, with the aim of least perturbation in existing excitation distribution, the recent investigation considers perturbation in edge elements excitation subject to null placement. A schematic of the proposed method has been illustrated in Fig. 1. In Fig. 1, the desired excitation for edge elements has been considered as A_+ and A_- with respect-

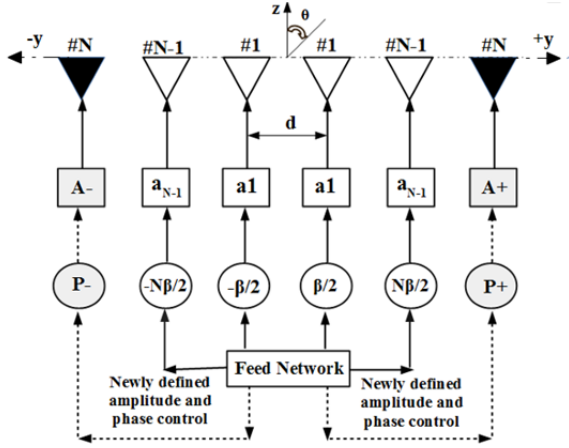

Fig. 1. Schematic of the proposed method.

tive phases P_+ and P_- . Subscript '+' and '-' have been assigned to denote the positive and negative side of the array axis respectively. Corresponding modified array factor expression for edge elements has been given in (11)

$$AF_E(\theta)|_{\text{m}} = A_- e^{-jP_-} e^{-j\left(\frac{2N-1}{2}\right)\psi} + A_+ e^{jP_+} e^{j\left(\frac{2N-1}{2}\right)\psi}. \quad (11)$$

Based on the symmetry of the array, it has been considered that $A_+ = A_- = A$ and $P_+ = P_- = -P$ resulting in array factor expression of (12)

$$AF_E(\theta)|_{\text{m}} = 2A \cos\left[\left(\frac{2N-1}{2}\right)\psi - P\right]. \quad (12)$$

Consequently, the total modified array factor expression is given by (13)

$$AF_m(\theta) = AF_R(\theta) + AF_E(\theta)|_{\text{m}}. \quad (13)$$

For desired null location at $\theta = \theta_n$ results in $\psi = \psi_n = kd(\sin\theta_n - \sin\theta_s)$. In order to reduce the synthesis problem in one dimension, the value of $P = -\pi/2 - \psi/2$ has been so chosen that the corresponding value of the array factor is zero. Substitution of P in (12) results in a modified array factor given by (14)

$$AF_m(\theta) = 2 \sum_{n=1}^{N-1} a_n \cos\left[\left(\frac{2n-1}{2}\right)\psi\right] - 2A \sin(N\psi). \quad (14)$$

At null position, $AF_m(\theta) = 0$ resulting in expression for A given by (15) where $\psi_n = kd(\sin\theta_n - \sin\theta_s)$

$$A = \frac{\sum_{n=1}^{N-1} a_n \cos\left[\left(\frac{2n-1}{2}\right)\psi_n\right]}{\sin(N\psi_n)}. \quad (15)$$

Equation (16) represents array factor expression for edge element contribution in odd numbered linear array.

$$AF_E(\theta)|_{\text{m}} = A_- e^{-jP_-} e^{-jN\psi} + A_+ e^{jP_+} e^{jN\psi}. \quad (16)$$

In (16), A_+ and A_- represent the amplitude excitation of edge elements on the right and left hand side of the array axis respectively. On substitution of the conditions $A_+ = A_-$

$= A$ and $P_+ = P_- = -P$ in (16), results in array factor expression of (17)

$$AF_E(\theta)|_{\text{m}} = 2A \cos[N\psi - P]. \quad (17)$$

If θ_n is the null placement coordinate with the value of $P = -\pi/2 - \psi/2$ then on substitution of P in (17), overall modified array factor is given by (18)

$$AF_m(\theta) = 2 \sum_{n=1}^N a_n \cos[(n-1)\psi] - 2A \sin\left[\left(\frac{2N+1}{2}\right)\psi\right]. \quad (18)$$

For $\theta = \theta_n$, the array factor expression of (18) reduces to $AF_m(\theta) = 0$ and $\psi = \psi_n$, resulting in the value of A as given by (19)

$$A = \frac{\sum_{n=1}^N a_n \cos[(n-1)\psi_n]}{\sin\left[\left(\frac{2N+1}{2}\right)\psi_n\right]}. \quad (19)$$

Consequently, excitation amplitude for edge elements depends on excitations of other elements of the array which is not the same as the method reported in [18]. As examples, two design instances of 8 and 15 elements linear array with null positions at 38° and -24° have been considered. Respective main beam positions for 8 and 15 elements linear array the main beam coordinate has been kept at 0° and 10° along with inter element spacing of 0.5λ wherein λ is the free space wavelength corresponding to the operating frequency. Further, it must be noted that for both design instances considers Dolph Tschebyscheff distribution and null position at peak side lobe level has been selected to illustrate the effectiveness of the method. However, in the analytical method the excitation amplitude for edge elements has been calculated using (19) whereas excitation conditions for other elements of the array correspond to the initial Dolph Tschebyscheff distribution. Resultant array factor plots representing desired null placement have been illustrated in Fig. 2 and Fig. 3, respectively. To illustrate desired null placement, as a representative excitation distribution, the Dolph Tschebyscheff distribution with peak side lobe level (SLL) of -20 dB has been considered.

In the first design instance (Fig. 2), null formation around the desired null location has been observed. The second design instance (Fig. 3) further confirms desired null placement in an odd numbered linear array. Moreover for the first design instance, null depth of -57 dB with null width of 1° has been observed and the second design instance shows null depth of -60 dB along with null width of 0.5° . Consequently, the proposed analytical method of null placement has been successful in achieving desired null placement with the least perturbation and sufficient null depth. However, it has also been observed that modified pattern due to null placement adversely affects radiations parameters such as first null beamwidth (FNBW), Directivity (D), peak sidelobe level (PSLL) and main beam position (θ_s), which has been summarized in Tab. 1. From Tab. 1 it has been observed that null placement has adversely affected all the considered radiation parameters. As a consequence, the proposed method achieves desired null

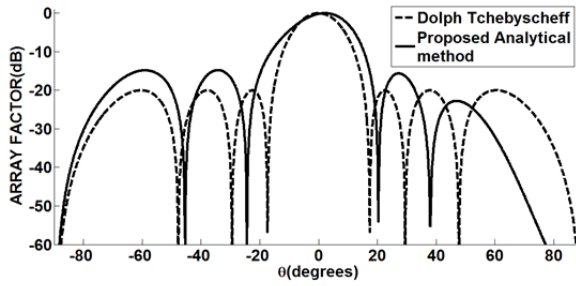

Fig. 2. Array factor plot of 8 elements linear array using Dolph Tschebyscheff distribution and the proposed method of null placement at 38° .

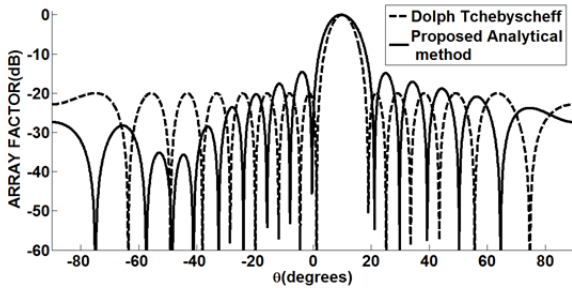

Fig. 3. Array factor plot of 15 elements linear array using Dolph Tschebyscheff distribution and the proposed method of null placement at -24° .

Method Name	$N = 8$ and $\theta_n = 38^\circ$					
	HPBW (deg)	PSLL (dB)	FNBW (deg)	Amplitude (A)	Phase (P) (rad)	θ_s (deg)
Analytical Method (proposed)	15.2	-14.76	44.7	0.65	0.603	2.1°
Dolph Tschebyscheff Method	14.2	-20	34.8	NA	NA	0°
$N = 15$ and $\theta_n = -24^\circ$						
Analytical Method (proposed)	7.7	-16.8	18.6	0.49	2.21	9.6°
Dolph Tschebyscheff Method	6.4	-20	14.4	NA	NA	10°

Tab. 1. Effect on radiation parameters and corresponding edge element control.

placement at the expense of pattern degradation and hence needs additional correction for restoration of the radiation pattern.

3. Constrained Null Placement Method

To facilitate the additional computational capability of the proposed method, the recent investigation considers evolutionary algorithm based least perturbation to achieve constrained null placement. As such adverse effects of null placement have been modeled as multiple objective optimization problems with fitness functions of (20) to (23). The fitness function given by (20) corresponds to desired null placement, wherein θ_n represents the desired value of single null placement along with $\psi_n = kd(\sin\theta_n - \sin\theta_s)$.

$$f_1 = 2 \sum_{n=1}^{N-1} a_n \cos \left[\left(\frac{2n-1}{2} \right) \psi_n \right] - 2A \cos \left[\left(\frac{2N-1}{2} \right) \psi_n - P \right]. \quad (20)$$

Peak side lobe level control has been modeled using (21). In (21), R_{dB} defines existing absolute PSLL and the second part of the equation has been considered for the side lobe region (SLR). The SLR has been defined as $\theta = [0^\circ, \theta_{FNL}]$ and $[\theta_{FNR}, 180^\circ]$ wherein θ_{FNL} and θ_{FNR} correspond to first nulls at left and right side around the main beam position (θ_s).

$$f_2 = \left| R_{dB} - \max \left\{ 20 \log \left| \frac{AF_m(\theta)}{AF_m(\theta_s)} \right| \right\} \right| \quad (21)$$

FNBW control has been realized using fitness function given by (22), where $FNBW_E$ represents FNBW value of existing excitation distribution (which in the present investigation has been Dolph Tschebyscheff distribution) and $FNBW_c$ correlates to the calculated value:

$$f_3 = |FNBW_E - FNBW_c|. \quad (22)$$

Main beam position control has been achieved using fitness function given by (23) with $\theta_{s|existing}$ being the existing main beam position of the Dolph Tschebyscheff distribution. Further $\theta_{s|modified}$ corresponds to the modified main beam position due to null placement.

$$f_4 = \left| \theta_{s|existing} - \theta_{s|modified} \right| \quad (23)$$

Fitness functions of (20) to (23) have been combined using the weighted sum method resulting in a single objective fitness function given by (24)

$$Fitness = \alpha f_1 + \gamma f_2 + \tau f_3 + \eta f_4. \quad (24)$$

In (23), α , γ , τ and η represent the respective weight for f_1 , f_2 , f_3 , and f_4 . Present investigation considers $\alpha = \gamma = \tau = \eta = 1$ indicating equal influence of all the fitness functions in the optimization process. It must be noted that array factor expressions used in the fitness functions correspond to modified array factor expressions of (14) and (18). Further particle swarm optimization (PSO) [12] and differential evolution (DE) [13] have been considered as representative evolutionary algorithms. The control parameters mentioned in [12] and [13] have been used in the current investigation. For both the design instances PSO and DE have been used to find out the optimum value of ' A ' and ' P ' pertaining to minimum fitness function value. Consequently, search space comprises of probable values of ' A ' and ' P '. Subsequently, component of search space associated with excitation amplitude has been randomly defined within minimum value of initial amplitude distribution and 0.001. Moreover, upper and lower limit of ' P ' has been set to $+90^\circ$ and -90° respectively. Synthesis objectives for PSO and DE for design instances of 8 and 15 elements have been summarized in Tab. 2.

Stopping criteria for the two algorithms have been set at maximum iteration cycles, i.e. optimizers would cease to execute once the 100th iteration cycle has reached. Further

Design Instance	Desired Objectives			
	PSLL (dB)	FNBW (deg)	Null position (θ_n) (deg)	θ_s (deg)
Design-I (8 elements)	-20	34.8	38	0°
Design-II (15 elements)	-20	14.4	-24	10°

Tab. 2. Synthesis objectives for PSO and DE.

number of agents searching for the optimum value has been set at 25 for both the algorithms. The effectiveness of evolutionary algorithm based edge element controlled null placement has been illustrated in Fig. 4 to Fig. 7. The array factor plots for the two design instances have been represented in Fig. 4 and Fig. 5. In both the figures, a comparison with the analytical method discussed in Sec. 2 has been carried out. From the array factor plots it has been observed that both PSO and DE based methods of null placement have been successful in achieving the desired objective of null placement, PSLL, and beam broadening. However the exact value of FNBW has not been achieved revealing limitation of the methods. A corresponding optimization curve for the best of the 25 independent run cycles has been shown in Fig. 6 and Fig. 7. From the optimization curves, it has been observed that both PSO and DE based methods converge to the same near zero value in an asymptotic manner for both the design instances which in turn indicates partial attainment of desired FNBW.

To further elucidate the partial attainment of objectives comparative study of both the design instances of 8 and 15 elements array has been carried out. Results of the

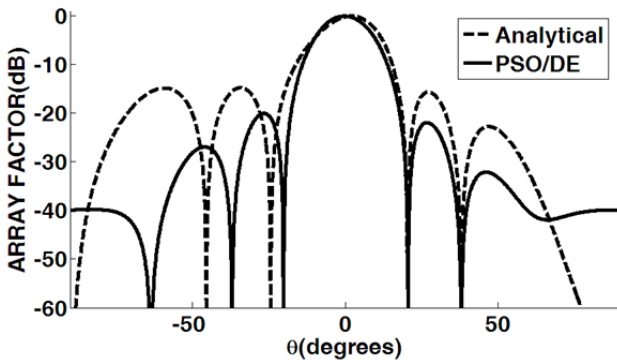

Fig. 4. Array factor plot for 8 elements linear array realized using PSO/DE with four objective functions.

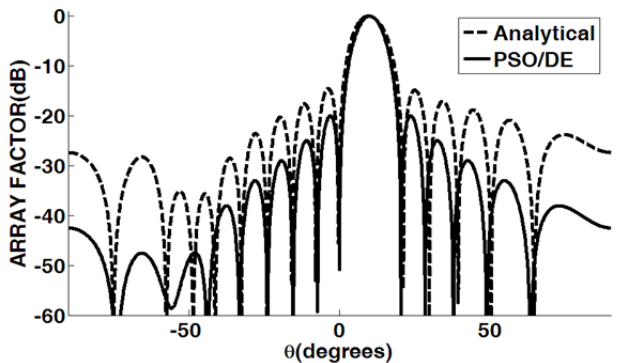

Fig. 5. Array factor plot for 15 elements linear array realized using PSO/DE with four objective functions.

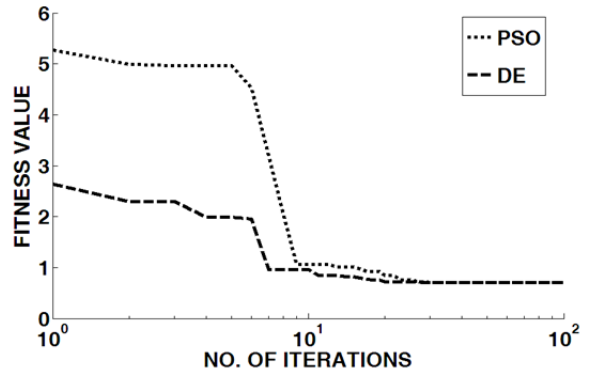

Fig. 6. Convergence profile of PSO and DE used for 8 elements array with four objective functions.

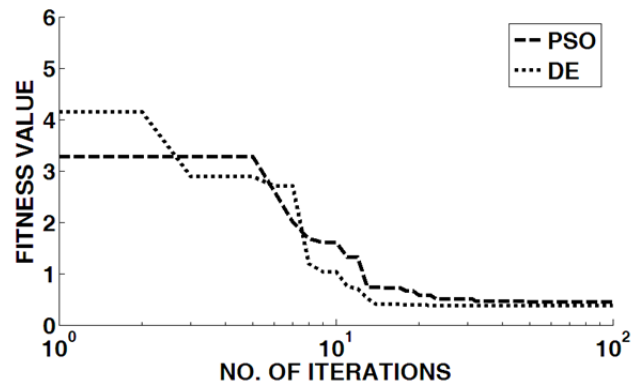

Fig. 7. Convergence profile of PSO and DE used for 15 elements array with four objective functions.

study have been summarized in Tab. 3. FNBW values in Tab. 3 indicate partial attainment of beamwidth narrowing for both the design instances. Further, it must also be noted that all other objectives of null placement, SLL reduction, and main beam position control have been successfully accomplished.

Moreover, a qualitative comparative study with representative existing methods has been carried and the results have been summarized in Tab. 4.

From Tab. 4 it has been observed that in [11], [13], [17], [19], [20], [22], [23], [25–28] with the increase in array size optimization parameters increase linearly leading to more computational time. Moreover with an increase in constraints multiple objective attainment level gets adversely

Method Name	$N = 8$ and $\theta_n = 38^\circ$					
	θ_s (deg)	HPBW (deg)	PSLL (dB)	FNBW (deg)	Amplitude (A)	Phase (P) (rad)
Analytical Method	2.1	15.2	-14.7	44.7	0.65	0.603
PSO/DE	0	16.2	-20	40.8	0.78	-0.12
$N = 15$ and $\theta_n = -24^\circ$						
Analytical Method	9.6	7.7	-16.8	20.7	0.49	2.21
PSO/DE	10	8.3	-20	20.6	0.36	-2.47

Tab. 3. Parametric effect of null placement and corresponding edge element control with four objective functions.

Year /Ref.	Algorithm	Antenna array	Optimization objectives	Optimization parameters (Problem dimension equals)	Execution time reduction
2021 /[28]	Mayfly Algorithm (MA)	Linear Antenna Array	SLL reduction/SLL reduction with null placement	Excitation amplitudes (Number of Elements/2)	85%
2020 /[27]	Teaching Learning Based Algorithm (TLBO)	Linear Antenna Array	Beam and null steering	Position and phase of array elements (Number of Elements)	90%
2020 /[26]	Genetic Algorithm and Schelkunoff Polynomial	Circular Antenna Array	Beam and null steering	Excitation amplitude (Number of Elements/2)	65%
2019 /[25]	Strawberry Algorithm (SBA)	Linear Antenna Array/ Circular Antenna Array	SLL reduction under constraints of first null beamwidth	Position and/or excitation amplitudes (Number of elements)	50%
2018 /[23]	Flower Pollination	Linear Antenna Array	SLL reduction and null control	Excitation amplitudes or position of elements (Number of Elements/2)	75%
2017 /[22]	Particle Swarm Optimization	Linear Antenna Array	Suppressed SLL, minimum HPBW, improved directivity and null placement	Excitation amplitudes and elements position (Number of elements)	24%
2015 /[20]	Spider Monkey Optimization	Linear Antenna Array	SLL reduction and null control	Excitation amplitudes (Number of Elements/2)	75%
2015 /[19]	PSO with Schelkunoff Method	Linear Antenna Array	SLL reduction and null control	Excitation amplitudes (Number of Elements+1/2)	82%
2013 /[17]	Genetic Algorithm	Linear Antenna Array	SLL reduction and FNBW control	Excitation amplitudes and elements position (Number of elements)	24%
2012 /[13]	Composite Differential Evolution	Linear Antenna Array	SLL reduction and null control	Elements Position (Number of Elements+1/2)	45%
2010 /[11]	Pattern Search	Linear Antenna Array	SLL reduction and null control	Excitation amplitudes and elements position (Number of elements)	35%
<i>Proposed method</i>	<i>PSO or DE with edge element controlled null placement method</i>	<i>Linear Antenna Array</i>	<i>Null placement along with SLL, beamwidth and main beam position control</i>	<i>Amplitude and Phase of edge elements (Two elements and does not depend upon array size)</i>	<i>95.3%</i>

Tab. 4. Comparison of the proposed method with different algorithms.

affected. However, the proposed optimization parameters are fixed at two and are independent of array size. As such computational time doesn't get adversely affected even if array size increases. Further it has also been observed that

proposed method performs better than other methods reported in [11], [13], [17], [19], [20], [22], [23], [25–28] even in increased constrain scenario.

4. Simulation and Validation

The present investigation considers isotropic element as an array element. In practice it is desirable to further investigate the synthesis results using practical radiators that closely resemble isotropic radiators. Subsequently, simulation based validation using 3D electromagnetic solver (HFSS) has been carried out to ensure practical acceptability of the proposed constrained based null placement in linear array.

4.1 Design of Circular Monopole Antenna

To ascertain the practical acceptability of the synthesis results of evolutionary algorithm-based constrained null placement method of validation using 3D electromagnetic solver (HFSS) has been developed. The first step of the validation method involves the design of a printed circular monopole antenna (PCMA) at an operating frequency (f_r) of 10 GHz. Design parameters thus obtained has been summarized in Tab. 5.

The antenna is designed on a standard FR4 substrate material with a typical dielectric constant of 4.4 at a height of 1.57 mm. Further it must be noted that design equations reported in [31] has been used to develop the PCMA as illustrated in Fig. 8.

4.2 Design of Circular Monopole Antenna Array

Schematic for 8 and 15 elements linear array using PCMA designed at 10 GHz has been represented in Fig. 9. The design parameters for both the design instances have

Design parameter	Value
Substrate length (L_s)	26.5 mm
Substrate width (W_s)	20.5 mm
Substrate height (h)	1.57 mm
Monopole radius (r)	5.27 mm
Feed line length (L_p)	13 mm
Feed line width (W_p)	1.5 mm

Tab. 5. Design parameters of PCMA at 10 GHz.

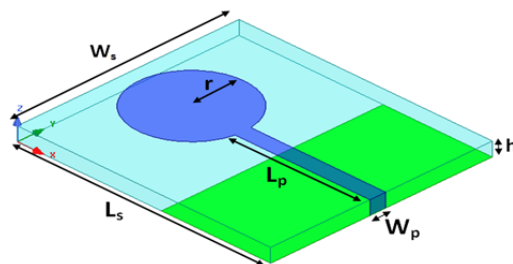

Fig. 8. Schematic of printed circular monopole antenna in HFSS at $f_r=10$ GHz.

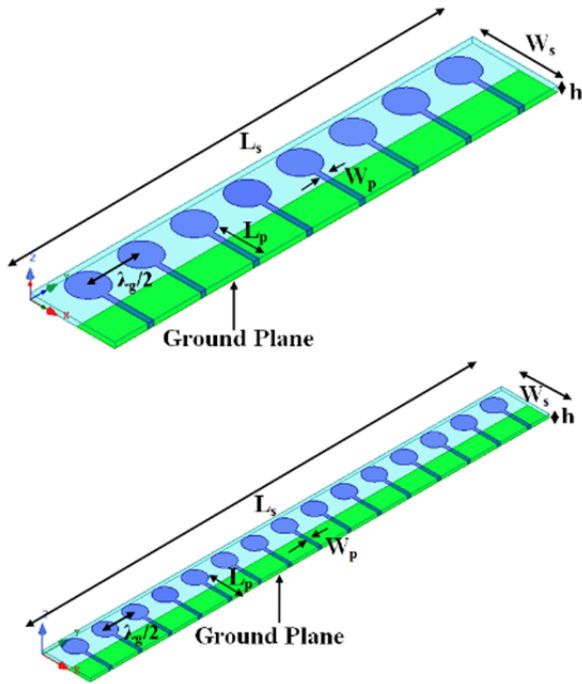

Fig. 9. Schematic of 8 elements and 15 elements PCMA array.

been summarized in Tab. 6. For both the design instances, inter element spacing of $\lambda_g/2$ has been considered wherein λ_g is guided wavelength. Each element of the array has been individually fed with optimized amplitude distribution corresponding to constrained null placement.

Table 7 summarizes the amplitude distribution for both the design instances. Dielectric properties of two array design instances have been kept identical to that of simple PCMA (refer to Fig. 8). Further the first design instance of 8 elements array considers the main beam perpendicular to the array axis (y-axis) representing broadside configuration. The second design instance considers the main beam at 10° representing the beam steered array. In Tab. 7, entries in the bracket represents phasor (in radian) associated with each excitation amplitude. Correspondingly, synthesis results obtained in MATLAB and HFSS have been illustrated in Fig. 10 and Fig. 11.

Further Table 8 summarizes the comparative study of the gain plots for both design instances. From Tab. 8 it has been observed that there has been an average deviation of 8.27% and 9.65% for 8 and 15 elements linear array design instances. Such deviation has been primarily due to the non-inclusion of the mutual coupling model in the synthesis

Design parameter	Parameter values	
	8 elements PCMA	15 elements PCMA
Substrate length (L_s)	125.4 mm	230.4 mm
Substrate width (W_s)	26.5 mm	26.5 mm
Substrate height (h)	1.57 mm	1.57 mm
Feed line length (L_p)	13 mm	13 mm
Feed line width (W_p)	1.5 mm	1.5 mm

Tab. 6. Design parameters of PCMA for two design instances.

Design instance I (8 elements)							
a_1 (P_1)	a_2 (P_2)	a_3 (P_3)	A (P)				
3.21 (0)	2.81 (0)	2.12 (0)	0.78 (-0.12)				
Design instance II (15 elements)							
a_1 (P_1)	a_2 (P_2)	a_3 (P_3)	a_4 (P_4)	a_5 (P_5)	a_6 (P_6)	a_7 (P_7)	A (P)
1.66 (0)	1.64 (0.17)	1.57 (0.34)	1.43 (0.68)	1.26 (1.32)	1.06 (2.64)	0.85 (2.14)	0.36 (-2.46)

Tab. 7. Optimum excitation for validation using HFSS.

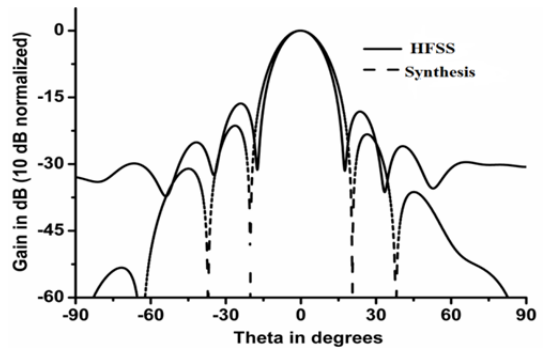

Fig. 10. A gain plot of 8 elements PCMA array with desired null at 38° at $\varphi = 90^\circ$ and $\theta_s = 0^\circ$.

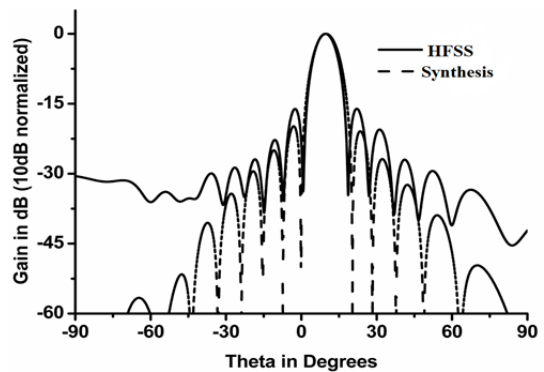

Fig. 11. A gain plot of 15 elements PCMA array with desired null at -24° at $\varphi = 90^\circ$ and $\theta_s = 0^\circ$.

Design instance of 8 elements array					
Method validation using	HPBW (deg)	PSLL (dB)	FNBW (deg)	θ_s (deg)	θ_n (deg)
MATLAB	16.2	-20	40.8	0	38
HFSS	14.71	-16.52	34.8	0	34.6
% deviation	9.19	8.53	14.7	0	8.95
Design instance of 15 elements array					
MATLAB	8.3	-20	20.6	10	-24
HFSS	7.6	-16.26	18	9.8	-22.44
% deviation	8.43	18.7	12.62	2	6.5

Tab. 8. Radiation parameter comparison (HFSS vs. MATLAB).

method. However, 3D electromagnetic solver based validation process confirms the practical acceptability of the proposed method of constrained null placement with moderate deviation.

5. Conclusion

The present article demonstrates the least perturbation in the excitation based analytical method of null placement in beam steered linear antenna array. The effectiveness of the method has been illustrated through two design instances of 8 and 15 elements array representing even and odd symmetry. Further performance improvement of the method has been carried out using evolutionary algorithms. Results obtained from the multi-objective synthesis confirm performance improvement. In order to ascertain the practical acceptability of the synthesis results 3D electromagnetic solver based validation process has been developed. The results obtained are then compared with the synthesis results. From the comparative study, it has been observed that for both the design instances there is a moderate deviation from the synthesis results. Such deviation has been due to non inclusion of the mutual coupling model in the synthesis method. Subsequently, it can be concluded that the validation method ascertains constrained null placement in linear array with certain uniform practical limitations which is one of the key components of the future scope of current investigation.

References

- [1] SCHELKUNOFF, S. A. A mathematical theory of linear arrays. *Bell System Technical Journal*, 1943, vol. 22, no. 1, p. 80–107. DOI: 10.1002/j.1538-7305.1943.tb01306.x
- [2] APPLEBAUM, S. Adaptive arrays. *IEEE Transactions on Antennas and Propagation*, 1976, vol. 24, no. 5, p. 585–598. DOI: 10.1109/TAP.1976.1141417
- [3] EL-AZHARY, I., AFIFI, M. S., EXCELL, P. S. A simple algorithm for sidelobe cancellation in a partially adaptive linear array. *IEEE Transactions on Antennas and Propagation*, 1988, vol. 36, no. 10, p. 1484–1486. DOI: 10.1109/8.8637
- [4] IBRAHIM, H. M. Null steering by real weight control- A method of decoupling the weights. *IEEE Transactions on Antennas and Propagation*, 1991, vol. 39, no. 11, p. 1648–1650. DOI: 10.1109/8.102781
- [5] ISMAIL, T. H., DAWOUD, M. M. Null steering in phased arrays by controlling the element positions. *IEEE Transactions on Antennas and Propagation*, 1991, vol. 39, no. 11, p. 1561–1566. DOI: 10.1109/8.102769
- [6] HAUPT, R. L., HAUPT, S. E. Phase only adaptive nulling with a genetic algorithm. In *IEEE Aerospace Conference*. Snowmass (CO, USA), 1997, p. 151–160. DOI: 10.1109/AERO.1997.574858
- [7] HEJRES, J. A. Null steering in phased arrays by controlling the positions of selected elements. *IEEE Transactions on Antennas and Propagation*, 2004, vol. 52, no. 11, p. 2891–2895. DOI: 10.1109/TAP.2004.835128
- [8] DONELLI, M., AZARO, R., DE NATALE, F. G. B., et al. An innovative computational approach based on a particle swarm strategy for adaptive phase arrays control. *IEEE Transactions on Antennas and Propagation*, 2006, vol. 54, no. 3, p. 888–897. DOI: 10.1109/TAP.2006.869912
- [9] MOUHAMADOU, M., ARMAND, P., VAUDON, P., et al. Interference suppression of the linear antenna arrays controlled by phase with use of SQP algorithm. *Progress in Electromagnetic Research*, 2006, vol. 59, p. 251–265. DOI: 10.2528/PIER05100603
- [10] LENG, S., SER, W., KO, C. C. A simple constrained based adaptive null steering algorithm. In *Proceedings of the 16th European Signal Processing Conference*. Lausanne (Switzerland), 2008, p. 1–5. ISSN: 2219-5491
- [11] GUNES, F., TOKAN, F. Pattern search optimization with applications on synthesis of linear antenna arrays. *Expert Systems with Applications*, 2010, vol. 37, no. 6, p. 4698–4705. DOI: 10.1016/j.eswa.2009.11.012
- [12] ZUNIGA, V., ERDOGAN, A. T., ARSLAN, T. Adaptive radiation pattern optimization for antenna arrays by phase perturbations using particle swarm optimization. In *Proceedings of NASA/ESA Conference on Adaptive Hardware and Systems*. Anaheim (CA, USA), 2010, p. 209–214. DOI: 10.1109/AHS.2010.5546256
- [13] LI, X., YIN, M. Optimal synthesis of linear antenna array with composite differential evolution algorithm. *Scientia Iranica*, 2012, vol. 19, no. 6, p. 1780–1787. DOI: 10.1016/j.scient.2012.03.010
- [14] BHATTACHARYA, R., BHATTACHARYA, T. K., GARG, R. Position mutated hierarchical particle swarm optimization and its application in synthesis of unequally spaced antenna arrays. *IEEE Transactions on Antennas and Propagation*, 2012, vol. 60, no. 7, p. 3174–3181. DOI: 10.1109/TAP.2012.2196917
- [15] MEHMOOD, S., KHAN, Z. U., ZAMAN, F., et al. Performance analysis of the different null steering techniques in the field of adaptive beamforming. *Research Journal of Applied Sciences, Engineering and Technology*, 2013, vol. 5, no. 15, p. 4006–4012. DOI: 10.19026/RJASET.5.4468
- [16] RECIQUI, A., BENTARZI, H. Null steering of Dolph-Chebyshev arrays using Taguchi method. *The International Arab Journal of Information Technology*, 2013, vol. 10, no. 2, p. 120–125.
- [17] GOSWAMI, B., MANDAL, D. A genetic algorithm for the level control of nulls and side lobes in linear antenna arrays. *Journal of King Saud University-Computer and Information Sciences*, 2013, vol. 25, no. 2, p. 117–126. DOI: 10.1016/j.jksuci.2012.06.001
- [18] MOHAMMED, J. R., SAYIDMARIE, K. H. Null steering method by controlling two elements. *IET Microwaves, Antennas and Propagation*, 2014, vol. 15, no. 8, p. 1348–1355. DOI: 10.1049/iet-map.2014.0213
- [19] BANERJEE, S., DWIVEDI, V. V. Linear array synthesis using Schelkunoff polynomial method and particle swarm optimization. In *2015 International Conference on Advances in Computer Engineering and Applications*. Ghaziabad (India), 2015, p. 1–4. DOI: 10.1109/ICACEA.2015.7164785
- [20] AL-AZZA, A. A., AL-JODAH, A. A., HARACKIEWICZ, F. J. Spider monkey optimization: A novel technique for antenna optimization. *IEEE Antennas and Wireless Propagation Letters*, 2015, vol. 15, p. 1016–1019. DOI: 10.1109/LAWP.2015.2490103
- [21] SAXENA, P., KOTHARI, A. Linear antenna array optimization using flower pollination algorithm. *SpringerPlus*, 2016, vol. 5, p. 1–15. DOI: 10.1186/s40064-016-1961-7
- [22] RAHMAN, S. U., CAO, Q., AHMED, M. M., et al. Analysis of linear antenna array for minimum side lobe level, half power beamwidth, and nulls control using PSO. *Journal of Microwaves, Optoelectronics and Electromagnetic Applications*, 2017, vol. 16, p. 577–591. DOI: 10.1590/2179-10742017v16i2913
- [23] SINGH, U., SALGOTRA, R. Synthesis of linear antenna array using flower pollination algorithm. *Neural Computing and Applications*, 2018, vol. 29, p. 435–445. DOI: 10.1007/s00521-016-2457-7
- [24] MOHAMMED, J. R. Obtaining wide steered nulls in linear array patterns by optimizing the locations of two edge elements. *AEU-International Journal of Electronics and Communications*, 2019, vol. 101, p. 145–151. DOI: 10.1016/j.aeue.2019.02.004
- [25] SUBHASHINI, K. R. Antenna array synthesis using a newly evolved optimization approach: Strawberry algorithm. *Journal of*

- Electrical Engineering*, 2019, vol. 70, no. 4, p. 317–322. DOI: 10.2478/jee-2019-0062
- [26] HAMZA, A., ATTIA, H. Fast beam steering and null placement in an adaptive circular antenna array. *IEEE Antennas and Wireless Propagation Letters*, 2020, vol. 19, no. 9, p. 1561–1565. DOI: 10.1109/LAWP.2020.3009905
- [27] JAMUNAA, D., MAHANTI, G. K., HASOON, F. N. Synthesis of phase-only position optimized reconfigurable uniformly excited linear antenna arrays with a single null placement. *Journal of King Saud University-Engineering Sciences*, 2020, vol. 32, no. 6, p. 360–367. DOI: 10.1016/j.jksues.2019.04.005
- [28] OWOOLA, E. O., XIA, K., WANG, T., et al. Pattern synthesis of uniform and sparse linear antenna array using mayfly algorithm. *IEEE Access*, 2021, vol. 9, p. 77954–77975. DOI: 10.1109/ACCESS.2021.3083487
- [29] WANG, A., LI, X., XU, Y. BA-based low-PSLL beampattern synthesis in the presence of array errors. *IEEE Access*, 2022, vol. 10, p. 9371–9379. DOI: 10.1109/ACCESS.2022.3143577
- [30] YANG, C., OU, N., DENG, Y., et al. Pattern synthesis algorithm for range ambiguity suppression in the LT-1 mission via sequential convex optimizations. *IEEE Transactions on Geoscience and Remote Sensing*, 2022, vol. 60, p. 1–13. DOI: 10.1109/TGRS.2021.3099132
- [31] RAY, K. P. Design aspects of printed monopole antennas for ultra-wide band applications. *International Journal of Antennas and Propagation*, 2008, p. 1–8. DOI: 10.1155/2008/713858

About the Authors ...

Soumyo CHATTERJEE was born in Bolpur, West Bengal, India, in 1981. He received his B. Tech in Electronics and Communication Engineering from BIET, Suri, India in 2005. He completed his master's degree from ETCE Department of Jadavpur University, India in 2009. He has completed his Ph.D. degree from Jadavpur University on the topic of pattern synthesis of antenna array using evolutionary algorithms in January 2020. He is presently working as an Assistant Professor in the Department of ECE Heritage Institute of Technology, India. His research interests are antenna array, RF device modeling, evolutionary algorithms.

Baisakhi BANDYOPADHYAY was born in West Bengal, India, in 1992. She received B. Tech degree from WBUT and ME degree from BIT Mesra in Electronics and Communication Engineering. Presently she is pursuing a Ph.D. degree from IIT Kanpur. Her current research interests include antenna arrays, metamaterials and RCS reduction techniques.

Sayan CHATTERJEE was born in Kolkata, India, in 1980. He received BE degree (gold medal) in 2003 and received ME degree in 2005. He has completed his Ph.D. degree in 2015 from Jadavpur University. He has worked in SAMEER, India, as a Scientist and was involved in the design of various strategic microwave subsystem and systems from 2005 to 2009. He was deputed to California Institute of Technology, Northridge in 2007 as visiting scholar. Presently he is an Associate Professor in the Department of ETCE at Jadavpur University, Kolkata. He has received AICTE Carrier award for young teacher in 2015. He is a senior member of IEEE since 2008 and was served as treasurer and secretary of the IEEE Kolkata section from 2014 to 2017. His research interest includes microwave and millimeter wave antennas, passive devices, SIW based subsystem and the design of wide band slotted array antennas, device modeling.

Arijit MAJUMDAR was born in Kolkata, India, in 1972. He received a B.Sc. degree in Physics and a B. Tech. degree in Radio Physics and Electronics from Calcutta University, India, in 1994 and 1997, respectively. He has completed his Ph.D. at Jadavpur University, Kolkata, India in February 2020. In 1997, he joined the Indian Institute of Technology, Bombay, India, as a Research Associate and in 1998 joined the Society for Applied Microwave Electronics Engineering & Research (SA MEER), Kolkata, as a Scientist. He is currently in charge of the SAMEER Kolkata Centre. He has 19 years of experience in the design and development of microwave and millimeter wave components, subsystems, and systems for different applications. He has published a number of papers in international journals and conferences.